



B-Box Res 2.5~10.0 User Manual

Rev 2.1_2017

Without the written consent of BYD Company, no entity or individual shall extract, copy contents of the document. It is not allowed to be translated under any conditions.

Statement:

The product version update or any other changes should be subjected to adjust on the condition of BYD's notice. Unless otherwise agreed, the document should be used for guidance only, all statements information and suggestions in this document do not constitute any expression of contract or liability.

Please contact BYD directly if you have any further questions.

BYD Lithium Battery Company Limited

TEL: 0755-8988 8888

FAX: 0755-8961 9653

1 General information	
1.1 About this manual	4
1.2 Target group	4
1.3 Intended usage	4
1.4 B-Box and B-Plus definition	4
1.5 Identifying the product	4
2 Safety	5
2.1 Safety precaution	5
2.2 Safety guidelines for installation	6
3 Technical parameters	7
4 Technical explanation	8
5 Product overview	9
5.1 B-Box System brief introduction	9
5.2 B-Box configuration table	10
5.3 B-Box System diagram	10
5.4 General introduction of BMU	11
5.5 General introduction of B-Plus 2.5	12
5.6 Operating environment	13
5.7 B-Plus 2.5 address switch introduction	14
6 Cleaning and maintenance	15
6.1 Cleaning	15
6.2 Maintenance	15
6.2.1 Recharge requirement with normal storage	15
6.2.2 Recharge requirement with over discharge storage	16
7 Dispose special situation	16
7.1 Battery over discharged maintenance	16
7.2 Force Majeure	16
8 B-Box configuration list with different inverter	17
8.1 B-Box configuration list with SMA sunny island-On/Off grid	17
8.2 B-Box configuration list with GOODWE ES-On/Off grid	18
8.3 B-Box configuration list with GOODWE BP-On/ grid	18
8.4 B-Box configuration list with Victron Multiplus/Multigrd-On/Off grid	18
8.5 B-Box configuration list with Solax -On grid	19
8.6 B-Box configuration list with Victron Quattro- On/Off grid	19
9 Normal issues and solutions	21
9.1 Normal alarm displayed on the SRC of SMA sunny island and the solution	21
9.2 Normal alarm displayed on the APP of GOODWE and the solution	22
9.3 Normal alarm displayed on the screen of Solax and the solution	22
9.4 Normal alarm display on the BMU of B-Box and the solution	23
9.5 Normal alarm display on B-Plus 2.5 and solution	24
10 Warranty	26
11 Login in after service web	26

1 General Information

1.1 About this manual

This user manual introduces the B-Box product information, user guidance, safety caution items and normal failure and actions. Users can contact the after service center if any abnormal or urgent failure occurs.

1.2 Target Group

This user manual applies to the B-Box Res 2.5, B-Box Res 5.0, B-Box Res 7.5, and B-Box Res 10.0 products.

1.3 Intended usage

The B-Box can be used in household energy storage applications, including on/off grid system. The B-Box works with different inverter brands and the user should refer to the configuration list of approved inverter brands recommended by BYD.

1.4 B-Box and B-Plus definition

BYD battery box products B-Box Res 2.5~10.0 are defined as below:

B-Box: Battery Box

B-Plus2.5: battery unit with usable capacity of 2.56KWh, to be installed inside the cabinet as an energy storage module.

B-Box 2.5: Battery usable capacity is 2.56KWh (Includes 1pcs B-Plus2.5)

B-Box 5.0: Battery usable capacity is 5.12KWh (Includes 2pcs of B-Plus2.5)

B-Box 7.5: Battery usable capacity is 7.68 KWh (Includes 3pcs of B-Plus2.5)

B-Box 10.0: Battery usable capacity is 10.24KWh (Includes 4pcs of B-Plus2.5)

1.5 Identifying the Product

The Type Label describes the product identification, which is attached on the product. For safe usage, the user must be well-informed of the contents in the Type Label. The Type Label displays:

Product Name:

Product Type/Usable Capacity:

Usable Voltage:

Max Current Discharge & Charge:

Ambient Temperature Range:

2 Safety

2.1 Safety precaution

Warning, notice and caution

Users are kindly requested to use the battery which is supplied by BYD Lithium Battery Company Limited in strict accordance with the Datasheet and remarks included at the end of this document.

BYD Lithium Battery Co., Ltd. will not guarantee or accept the liability for a product installed and operated not in accordance to the guidance manual and resulting in an accident.



WARNING

Do not crush the battery and always dispose according to safety regulations (Do not dispose in fire or water).

Recharge Battery at least every 6 months (when in storage).

Once discharged, recharge battery within 7days. If there is no charging operation within 7days, please power off the battery and disconnect it from system

Do not expose to temperatures above 50°C and keep out of direct sunlight.

Ensure secure grounding. Do not reverse the front panel.

Do not short / reverse polarity or connect in series.

Disconnect from power and load before maintenance.

Only be operated by qualified professionals.

Store according to related standard.

Do not put one battery on top of another when unpackaged.

In the process of transportation and storage, the goods are not allowed to be stacked in layers or at a height greater than specified.

When increasing the battery capacity, users should first power off the battery and other power inputs.

B-Box products can only be used in home energy storage applications, and their use is not allowed for life-sustaining medical devices and automotive applications.



NOTICE

Continuous operation of a damaged B-Box can lead to a dangerous situation that may cause serious injury due to electrical shock. B-Box can only be operated when it is technically faultless and in an operationally safe state.

Regularly check the B-Box for visible damage making sure that all safety equipment is freely accessible at all times. If a B-Box is damaged, do not touch it.

Please contact a BYD after sales service supplier if a significant event message displays on the LCD or APP of the inverter.

 **CAUTION**

Li-ion battery inside, when disassembling the system, do not intentionally short the positive (+) and negative (-) terminals with metallic objects.

All works on system and electrical connections must be carried out by qualified personnel only. B-Box provides an emergency switch to be used for urgent situations.

A potentially hazard circumstance such as excessive heat or electrolyte mist may occur due to incorrect operation, damage or abuse. The safety precautions and the warning messages described are not fully understood, or if you have any questions, please contact after service for guidance. The safety section may not include all regulations for your region.

Personnel working with B-Box products must review applicable federal, state and local regulations as well as the industry standards regarding this product.

When transporting the system package as a bundle, remove the battery from cabinet and transport them separately.

2.2 Safety guidelines for installation

 **CAUTION**

Li-ion battery (energy storage unit) inside. When assembling the system, do not intentionally make a short condition between the positive (+) and negative (-) terminals of the battery box with a metallic object.

All works on the B-Box and electrical connections must be carried out by qualified personnel only. B-Box provides a safe source of electrical energy when operated as intended and as designed.

Potentially hazardous circumstances such as excessive heat or electrolyte mist may occur under improper operating conditions, damage, misuse and abuse. The following safety precautions and the warning messages described in this section must be observed. If any of the following precautions are not fully understood, or if you have any questions, contact customer service for guidance. The Safety Section may not include all regulations for your locale; personnel working with B-Box must review applicable federal, state and local regulations as well as the industry standards regarding this product.

Installation personnel cannot wear watches, etc., to avoid short circuit and man-made damage.

 **CAUTION**

Due to heavy weight of BYD B-Box Res 2.5~10.0, please use strong packaging and safety protection equipment during transportation, to ensure safety and avoid accidental damage.

3 Technical parameters

	B-Box Res 2.5	B-Box Res 5.0	B-Box Res 7.5	B-Box Res 10.0
Battery Type	Lithium Iron phosphate battery			
Battery module	B-Plus 2.5			
Max Output power(KW)	2.56	5.12	7.68[3]	10.24[3]
Peak Output Power[kW]	5.12 30s	5.12 30s	15.36 30s	15.36 30s
Usable battery energy(KWh)(100% DOD, 0.5C charge & discharge at @+25°C)(KWh)	2.56	5.12	7.68	10.24
Nominal voltage(V)	51.2			
Operating Voltage Range(V)	43.2~56.4			
Ambient Temperature Range[°C]	-10~+50			
Communication	RS485/CAN			
Cabinet Net Dimension(W*D*H mm)(Without ground feet)	620×1650×335			
Net Weight(Kg)	103	137	171	205
IP level	IP55			

When B-Box works in different temperatures, the charge and discharge current will be adjusted automatically, for detail parameter settings, please refer to the table below,

Parameter setting of charge current in various temperature

Protect temp. /Resume temp. (°C)	Normal current(A)
-7~2	0.06C*N
2~12	0.12C*N
12~50	0.7C*N
Remark: 1.Effective time is 2mins when change from one temperature range to another.) 2.N=B-Plus2.5 battery quantity	
Discharge current control with temperature	
Protect temp./ Resume temp.(°C)	Normal current(A)
-20~50/(-15-50)	0.7~1C*N

Remark:

1.N= B-Plus2.5 U battery quantity

4 Technical explanation

No.	Terms	Comment
1	Discharge	Battery output power for load
2	Charge	Battery power supply(such as DC charger)
3	Full charged	Battery full charge, SOC is 100%.
4	Idle	Battery is on status of neither charge nor discharge and had not full charged.
5	Shutdown mode	Power off
6	SOC	State of Charge
7	SW	Software
8	HW	Hardware
9	Battery voltage	The voltage between B+/B-
10	Pack voltage	The voltage between P+/P-
11	Cell voltage	Single cell voltage
12	Failure	Battery or BMS are broken, need to change new unit
13	Alarm	Battery will stop charge or discharge immediately
14	Protect	When battery stops charging or discharging (e.g. cell is over voltage), operation can resume at a later stage.
15	Over discharged	Battery module or batteries overvoltage, need timely supplement electricity.

5 Product overview

5.1 B-Box System Brief introduction

B-Box is the short name for battery box, the energy storage part in the electric power system of a household, and the B-Box carries BYD's lithium battery offering excellent performance. There are 1/2/3/4 pcs batteries modules in each box, and the box support parallel connection to expend capacity from 2.5KWh to 80KWh, which can meet various capacity requirement for customers.

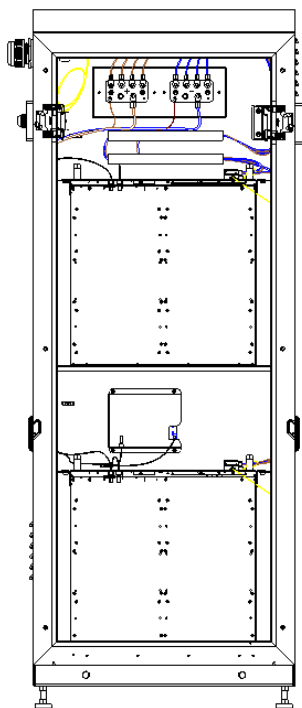

Internal view

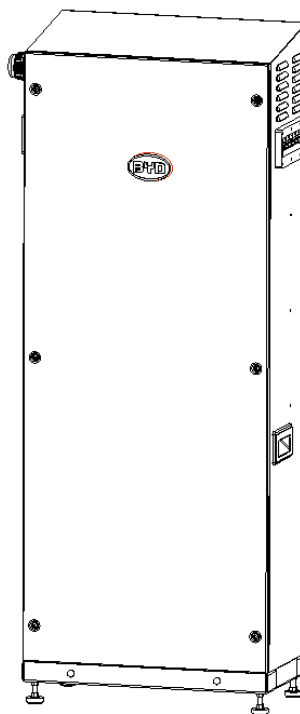

External drawing

5.2 B-Box configuration table

No.	Component	Name	Description
1	Cabinet	B-Box Cabinet	The Cabinet is used to install the B-Plus 2.5 inside and provide DC output(Each cabinet can install max 4pcs B-Plus2.5)
2	Battery	B-Plus2.5	Battery module with 51.2V50Ah, BYD's P/N is: U3A1-50P-A.
3	BMU	BMU	Battery management unit. Provide communication with external equipment.

5.3 B-Box System diagram

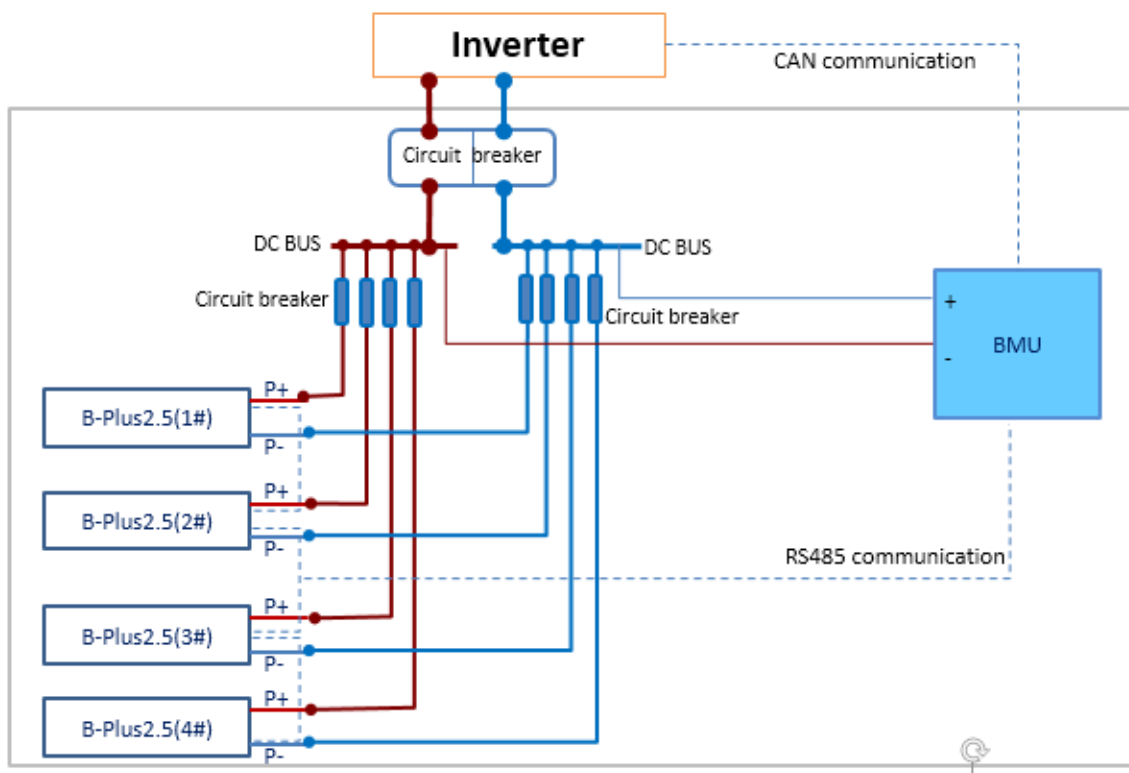

System diagram

5.4 General introduction of BMU

BMU is battery management unit which installed in cabinet; the function is to manage the battery's charge and discharge, select information from battery and report to inverter.

Main function:

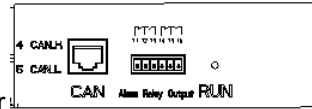

- ✓ CAN /RS485 communicate with inverter
- ✓ RS485 communicate with battery/BMS
- ✓ Dry contact terminal
- ✓ Other Communication interface for maintenance
- ✓ Charge and discharge management

5.5 General introduction of B-Plus 2.5

B-Plus is the commercial name of BYD U3A1-50P-A backup battery with 51.2V & 50Ah which is designed for energy storage application. B-Plus 2.5 is an integrated battery which consists of shell, BMS and cells.

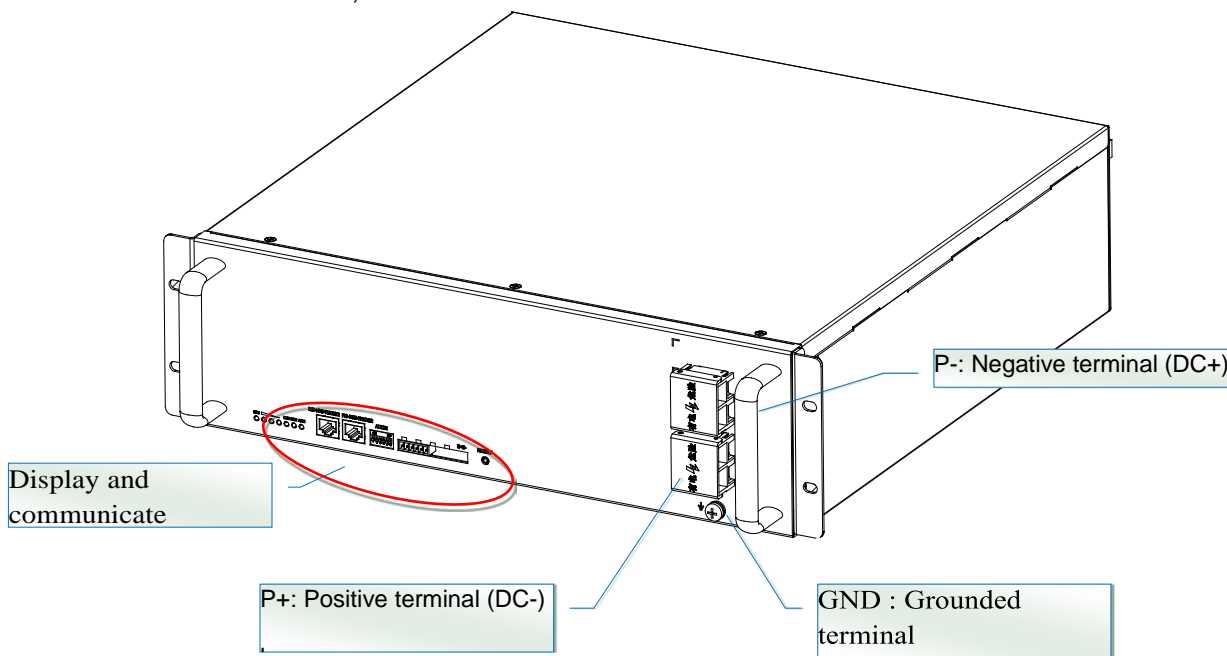

B-Plus 2.5 overview

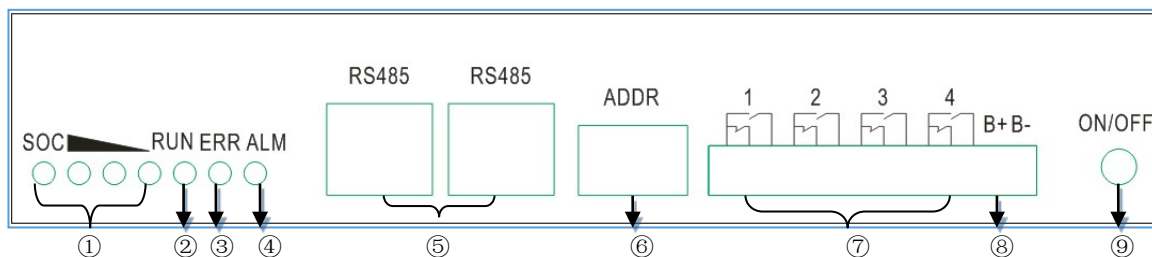

Display and communicate interface

No.	Interface	Mark	Function
①	SOC LED	SOC	Indicate State of capacity of battery
②	RUN LED	RUN	Indicate the Plus is running status
③	ERR LED	ERR ADDR	Indicate error status
④	ALM LED	Alarm	Indicate alarm status
⑤	RJ45 terminal	RS485	Communication ports
⑥	Address	ADDR	When parallel connection, need setting address.
⑦	Alarm relay output	1.2.3.4	Not using
⑧	Test terminal	B- B+	Measure battery voltage when testing.
⑨	ON/OFF	ON/OFF	Activity battery when no external powers add on battery.

5.6 Operating environment

Operating environment parameters

No.	Item	Requirement			Unit	Remark
		Min.	Typical	Max.		
1	Discharging temperature	-10	25	50	°C	
2	Charging temperature	-10	25	50	°C	
3	Relative humidity	5		95	%	
4	Absolute humidity	0.26		25	g/m3	
5	Elevation	-	2000	-	m	
6	IP level	20				

5.7 B-Plus 2.5 address switch introduction

After finished the battery installation, installer should setup battery address by “ADDR” switch.

“ADDR” switch introduction:

Function: Communicate between battery and BMU, BMU will communicate with external equipment when use CAN communication.

Each DIP switch definition:

There are 6 bit switches, keep the switch on down side means “0”, turn up the switch to “ON” means “1”.

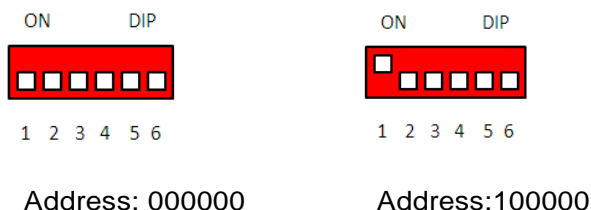

For example: when two battery in using, “ADDR” setting:

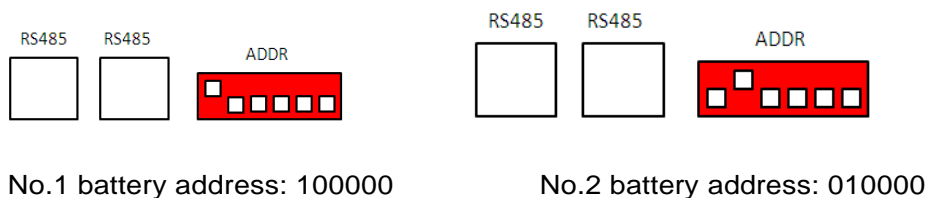

Please refer to the configuration list in Appendix1.

Notice: Make sure of the highest address of BMS connecting to BMU which communication with inverter.

6 Cleaning and maintenance

6.1 Cleaning



CAUTION:

When user needs to clean the B-BOX, please stop the system firstly.

The B-Box system is recommended to be cleaned periodically. If the enclosure is in a dirty condition, please use a soft and dry brush or a vacuum to remove the dirt. Do not use liquids such as solvents, abrasives or corrosive liquids in the enclosures.

6.2 Maintenance

6.2.1 Recharge requirement with normal storage

The B-Box should be installed in position with the temperature range of $-10^{\circ}\text{C} \sim +50^{\circ}\text{C}$. The load-bearing of battery's package is less than 300Kg, So don't let more than 7 modules in stack.

When the battery stored for a long time, need a regular maintenance according to the following table Charge battery with current of 0.5C (25A) for 1 hour when maintenance.

Storage parameters under different storage conditions-1

Storage environment temperature	Relative humidity of storage environment	Storage time	SOC
Below -20°C	/	prohibit	/
$-20\sim 25^{\circ}\text{C}$	5%~70%	≤ 12 months	$30\% \leq \text{SOC} \leq 60\%$
$25\sim 35^{\circ}\text{C}$	5%~70%	≤ 6 months	$30\% \leq \text{SOC} \leq 60\%$
$35\sim 45^{\circ}\text{C}$	5%~70%	≤ 3 months	$30\% \leq \text{SOC} \leq 60\%$
Above 45°C	/	prohibit	/

6.2.2 Recharge requirement with over discharge storage

When in storage, if module over discharged, the module will be damaged after several days if do not charge the module in time.

Storage parameters under different storage conditions-2

Storage environment temperature	Storage time
-20~25℃	≤15 days
25~45℃	≤7 days

7 Dispose special situation

7.1 Battery over discharged maintenance

When battery over discharge which may cause by black out, continuously rainy day, etc, the battery can provide limited energy, user should pay attention to the backup time of the battery.

7.2 Force Majeure

Catastrophic accidents, including lightning, floods, earthquakes, fires and other disasters, can bring unpredictable damage to the whole system.

8 B-Box configuration list with different inverter

8.1 B-Box configuration list with SMA sunny island-On/Off grid

1 Phase on Grid		
Inverter Type	B-Plus 2.5	Cabinets
SI 3.0M	≥1	≥1
SI 4.4M	≥1	≥1
SI 6.0H	≥1	≥1
SI 8.0H	≥1	≥1
Remark: Maximum B-Plus quantity is 32,Cabinet quantity is 8.		
3 Phase on Grid		
Inverter Type	B-Plus 2.5	Cabinets
SI 3.0M	≥3	≥1
SI 4.4M	≥4	≥1
SI 6.0H	≥4	≥1
SI 8.0H	≥4	≥1
1 Phase off Grid		
Inverter Type	B-Plus 2.5	Cabinets
SI 3.0M	≥3	≥1
SI 4.4M	≥3	≥1
SI 6.0H	≥5	≥2
SI 8.0H	≥5	≥2
3 Phase off Grid		
Inverter Type	B-Plus 2.5	Cabinets
SI 3.0M	≥8	≥2
SI 4.4M	≥8	≥2
SI 6.0H	≥12	≥3
SI 8.0H	≥12	≥3
Remark: Maximum B-Plus quantity is 32, Cabinet quantity is 8.		

8.2 B-Box configuration list with GOODWE ES-On/Off grid

1 Phase on Grid		
Inverter Type	B-Plus 2.5	Cabinets
3.6kW	≥1 ^①	≥1
4.6kW	≥1 ^①	≥1

1 Phase off Grid		
Inverter Type	B-Plus 2.5	Cabinets
3.6kW	≥2	≥1
4.6kW	≥2	≥1

Remark: Maximum B-Plus quantity is 32,Cabinet quantity is 8.

^①This configuration is only for self-consumption application

8.3 B-Box configuration list with GOODWE BP-On/ grid

1 Phase on Grid		
Inverter Type	B-Plus 2.5	Cabinets
2.5kW	≥1	≥1

Remark: Maximum B-Plus quantity is 32, Cabinet quantity is 8.

8.4 B-Box configuration list with Victron Multiplus/Multigrid-ESS Mode

1 Phase on Grid		
Inverter Type	B-Plus 2.5	Cabinets
3KVA	≥1	≥1
5KVA	≥1	≥1

1 Phase off Grid		
Inverter Type	B-Plus 2.5	Cabinets
3KVA	≥3	≥1
5KVA	≥5	≥2

3 Phase on Grid

Inverter Type	B-Plus 2.5	Cabinets
3KVA	≥3	≥1
5KVA	≥4	≥1

3 Phase off Grid

Inverter Type	B-Plus 2.5	Cabinets
3KVA	≥8	≥2
5KVA	≥12	≥3

8.5 B-Box configuration list with Solax -On grid

1 Phase on Grid

Inverter Type	B-Plus 2.5	Cabinet
SK-SU 3000	≥1	≥1
SK-SU 3700	≥1	≥1
S K-SU 5000	≥1	≥1

8.6 B-Box configuration list with Victron Quattro- ESS Mode

1 Phase on Grid

Inverter Type	B-Plus 2.5	Cabinet
5KVA	≥1	≥1
8KVA	≥1	≥1
10KVA	≥1	≥1
15KVA	≥1	≥1

1 Phase off Grid

Inverter Type	B-Plus 2.5	Cabinet
5KVA	≥3	≥1
8KVA	≥5	≥2
10KVA	≥6	≥2
15KVA	≥9	≥3

3 Phase on Grid

Inverter Type	B-Plus 2.5	Cabinet
5KVA	≥3	≥1
8KVA	≥4	≥1
10KVA	≥5	≥2
15KVA	≥6	≥2

3 Phase off Grid

Inverter Type	B-Plus 2.5	Cabinet
5KVA	≥9	≥3
8KVA	≥15	≥4
10KVA	≥18	≥5
15KVA	≥27	≥9

9 Normal issues and solutions

9.1 Normal alarm displayed on the SRC of SMA sunny island and the solution

SMA SRC	Reason	Solution
F221	External Alarm-Invalid Bat Type	Reset battery type to "Li" on SRC.
F920(XA01General)	1.AnyB-Plus2.5hasfailedto communicate with the BMU; 2.RS485communicationbetween the BMU and the B-Plus 2.5have failed;	1.Inspect whether the RS485 communicate cable has been connected correctly and reliability; 2.Inspect DIP switch setting according to the setting of DIP switch guidance in user manual; 3.Change BMU in cabinet;
F921(XA02DcHiVolt)	External Alarm - Battery High Voltage	
F922(XA03DcLoVolt)	External Alarm - Battery Low Voltage	If the red led of the B-Plus 2.5 is on, please contact the service provider to change the battery. If not, check the system settings according to the guidelines.
F923(XA04DcHiTmp)	External Alarm - Battery High Temp	
F924(XA05DcLoTmp)	External Alarm - Battery Low Temp	
F925(XA06DcHiTmpC)	External Alarm - Battery High Temp Charge	
F926(XA07DcLoTmpC)	External Alarm - Battery Low Temp Charge	
F927(XA08DcHiCur)	External Alarm - Battery High Current Discharge	
F928(XA09DcHiChgCur)	External Alarm - Battery High Current Charge	
F930(XA11Short)	External Alarm - Short circuit	1.Power off; 2.Inspect if there is short connection of cable between P+&P-; 3.If short connection is confirmed, please reconnect cable correctly; 4.restart battery;
F931(XA12Bms)	External Alarm - BMS internal	If the red led of the B-Plus 2.5 is on,

F932(XA13CellBal)	External Alarm - Cell imbalance	please contact the service provider to change the battery. If not, check the system settings according to the guidelines.
F952	External Alarm -ExtBMS Timeout	1.Inspect whether the CAN communication cable has been connected correctly and reliability; 2.Change BMU in cabinet;

9.2 Normal alarm displayed on the APP of GOODWE and the solution

APP of GOODWE	Reason	Solution
BMS status: Battery communication fail	Inverter and BMU communication failure	1.Inspect whether the CAN communication cable has been connected correctly and reliability; 2.Change BMU in cabinet;

9.3 Normal alarm displayed on the screen of Solax and the solution

Screen of Solax	Reason	Solution
BMS LOST	Inverter and BMU communication failure	1.Inspect whether the CAN communication cable has been connected correctly and reliability; 2.Change BMU in cabinet;

9.4 Normal alarm display on the BMU of B-Box and the solution

LED of the BMU	Reason	Solution
Flash 1 time	Inverter and BMU communication failure	1. Inspect whether the CAN communication cable has been connected correctly and reliability; 2. Change BMU in cabinet;
Flash 2 times	Battery not found	BMU and first battery connection check whether normal
Flash 3 times	Cell parts not found	Check for battery capacity lights in the form of the Lantern show, check the corresponding battery lines of communication, and the address is set correctly.
Flash 4 times	Any battery failure	Check battery light stay lit, and if so, please contact your Installer to replace the battery.

9.5 Normal alarm display on B-Plus 2.5 and solution

	B-Plus display info		Reason	Solution
LED	Yellow led(Alarm) blinks for 0.5Hz, other led is off ;		Battery has powered off abnormally;	Press ON/OFF button for 2-3 seconds to restart the battery, If the battery cannot be resumed, contact the service provider;
	Flashing Lantern (lantern and alternate capacity display, 10S cycle)		Communication connection timeout	Check the communication wire
	1/3 and 2/4 flashing		Update statue	If not update the firmware, reset the battery.
	Yellow led (Alarm) is normally on	1time	Under voltage (BAT or CELL)	Automatically resume
	1. press on/off button 1S release, hear a short buzzer sound;	2times	Over charge	Automatically resume
	2.run lights stay lit, ALM by flashing lights, showing alarm code;	3times	Low temperature charge over-current	Automatically resume
		4times	Charge short circuit	Automatically resume
		5times	Discharge short circuit	Automatically resume
		6times	Parallel short circuit	Automatically resume
		7times	Discharge over-current protection	Automatically resume
		8times	High temperature protection	Automatically resume

		9times	Low temperature protection	Automatically resume
		10times	PACK over voltage protection	Automatically resume
Red led (Err) is normally on		1time	Voltage sensor failure	Change the battery
		2times	Temperature sensor failure	Change the battery
	1) press the on/off button press the 1S released hear short buzzer sound;	3times	Charging circuit failure	Change the battery
		4times	Discharge circuit failure	Change the battery
	2) run lights stay lit, ERR by flashing lights, showing alarm code;	5times	Batteries failure	Change the battery
		6times	536 communication failure	Change the battery
Buzzer 15S for the cycle, each time the buzzer number of successive rings		4times	Reverse 、 short circuit	1.Power off; 2.Inspect short/reverse connection of cable between P+&P-; 3.If short/reverse connection is confirmed, please reconnect cable correctly; 4.restart battery;
		3times	Batteries failure	Change the battery
		2times	Voltage sensor failure、 Temperature sensor failure	Change the battery
		1time	Charging/Discharge circuit failure	Change the battery

10 Warranty

BYD provides warranty when the product is installed and used according to the description of user manual / installation manual / warranty letter.

11 Login in after service web

In order to get after service in time, after installation, please login your B-Box information in our after service operator web:

For technical problems or inquiries for usage, please contact our installation company.

The following information is required for timely customer service.

Product type

Serial Number

Connected PV module type and number

Option equipment

Any using problems please contact us by below address:

Contact us:

China

BYD LITHIUM BATTERY Co.,LTD

Customer Service Mailbox: eubatterygrp@byd.com

Telephone:+86 0755 89888888

Address:No.1 Baoping Road, Baolong Industrial Town, Longgang Shenzhen, 518116, China

Australia

Alps Power Pty Ltd

Customer Service Mailbox: service@alpspower.com.au

Telephone: +61 2 8005 6688

Address: 201/15 Chatham Road West Ryde NSW 2114 Australia