

BYD

TANG EV

OWNER'S MANUAL

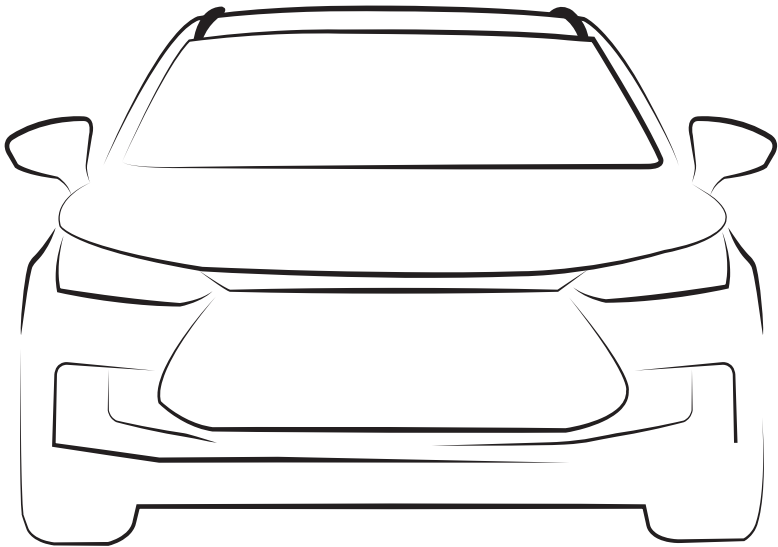

BUILD YOUR DREAMS

Preface

Dear BYD owner:

Thank you for choosing a BYD vehicle. Please read through this manual carefully before using the vehicle, and keep it safely afterwards.

This manual provides useful information on the vehicle's operation, safety and comfort features, and will prove useful in the full enjoyment of your driving experience.

If maintenance or repair is required, please contact the nearest BYD authorised dealer or service provider for high-quality after-sales service. Be sure to carefully follow this manual's maintenance instructions.

This manual is an integral part of the vehicle. Make sure to hand it over to the new owner upon re-sale.

Thank you for your purchase and support for BYD vehicles. We wish you a pleasant driving experience!

BYD Auto Industry Co., Ltd.

November 2021

BYD Auto Industry Co., Ltd. All rights reserved.

This manual may not be copied or reproduced without prior written permission of BYD Auto Industry Co., Ltd.

All rights reserved.

Note: The illustrations in this manual are only provided for reference. Anything in the actual vehicle shall prevail.

Introduction to Owner's Manual

Vehicle configuration and options

This manual contains the latest standard and optional features for this vehicle model. Your vehicle may not be equipped with some of the features or functions described. For specific equipment information, please refer to the corresponding sales material or consult the BYD authorised dealer or service provider where the vehicle was purchased.

Accessories, spare parts and modifications

Should any part of the vehicle needs to be replaced, use original accessories and spare parts.

Vehicle modification with accessories and spare parts other than BYD originals may affect the vehicle's maneuverability, safety and durability, and may infringe local laws or regulations. Problems like damage to the vehicle or its performance caused by unauthorised modification are not covered by its warranty - please refer to the warranty manual for further information on the policy.

Scrapping vehicle

Make sure to dismantle or scrap the vehicle in accordance with local regulations.

Quick search

This manual is organised into specific chapters. In order to quickly access the information desired, find the corresponding chapter by the coloured bars on the right edge of the odd-numbered pages (not applicable for all content).

The contents, index of illustrations, and detailed alphabetic index at the end of this manual can help quick access to the information searched.

Marks in manual

- * Only applicable to some models.



WARNING: Reminds you of any medium and high-level risks. Ignoring this information may cause serious or potentially life-threatening injury.



CAUTION: Reminds you of slight danger. Ignoring this information may cause damage to the vehicle.



REMINDER: Reminds you of auxiliary information that may be helpful.



SUSTAINABILITY: Provides additional environmental protection details.

Marks in illustrations

 Indicates the part currently being described.

 Indicates directional movement.

Unless otherwise specified, the directions (front, rear, left and right) of the vehicle in this manual shall be subject to the driving direction of the vehicle.

 Indicates operational actions.

Access the Owner's Manual digital copy*

The digital copy can be viewed by tapping on **Owner's Manual** on the centre console touchscreen.

REMINDER

- The digital copy of the Owner's Manual is constantly updated and upgraded, according to the frequency its software is updated. The digital version may differ slightly from the hard copy version found on board.

Relevance of Owner's Manual

As BYD products are improved and updated, the contents and illustrations in this manual will also be updated occasionally. No further notice will be given on such changes. Please refer to the actual vehicle status.

Sustainability

As a pure electric passenger vehicle, the BYD Tang EV is an environmentally friendly product. Please visit <https://reach.bydeurope.com> for environmental protection information about the vehicle.

It is everyone's responsibility to protect the environment. Please use this vehicle properly and dispose of any waste and cleaning materials according to the corresponding local laws and regulations.

GETTING TO KNOW THE VEHICLE

Exterior..... 10

Interior 12

TRAVEL PREPARATION

Pre-Driving Inspection..... 16

UNLOCKING THE VEHICLE

Understanding the Keys 18

Remote Control Key..... 18

NFC Key Card* 21

Locating the Vehicle 21

With Remote Control Key..... 21

Unlocking 22

Remote Control Key..... 22

Microswitch..... 23

NFC Key Card* 23

LOADING

Small Items..... 26

Interior Storage..... 26

Luggage and Large Items 28

Opening/ Closing Boot..... 28

Boot Light..... 31

Luggage Lashing Eyes 31

Luggage Compartment Cover* 32

Folding Third Row Seats* 32

Loading..... 33

Roof Rack..... 33

WELCOMING AND GREETING

Opening Door..... 36

Exterior Handle 36

Welcoming..... 36

Exterior Welcoming..... 36

Interior Greeting 37

RIDING

Child Safety 40

Riding Instructions for Children..... 40

Electronic Child Protection Lock..... 40

Classification of Child Safety Seats (not provided with the vehicle)..... 41

Installing a Child Seat 41

Seat Belts 43

Protective Effect of Seat Belts 43

Correct Sitting Posture 43

Correct Use of Seat Belts..... 44

Wearing Seat Belts When Pregnant..... 45

Adjusting Front Seat Belt Height 46

Seat Belt Pre-Tensioner..... 46

Seat Belt Reminder 47

Checking Seat Belt System..... 47

Replacing Seat Belt System Components 47

Driving..... 47

Description of Power Status 47

Driver Seat Controls..... 48

Driver Window Control..... 51

Side Mirror Controls..... 51

Rear View Mirror Controls 53

Steering Wheel Controls 53

Locking Doors from Inside..... 57

Front Passenger Ride..... 57

Adjusting Seat..... 57

Controlling Passenger Window..... 57

Riding in the Second Row 57

Adjusting Seat..... 57

Controlling Rear Windows..... 58

Second Row Lighting..... 58

Riding in the Third Row* 58

Reaching Third Row Seats 58

Folding Seats 59

Third Row Lighting..... 59

Comfort Ride 60

A/C 60

Panoramic Sunroof/Sunshade 64

Sun Visors 65

Interior Roof Handle 66

Smartphone Wireless Charging 66

On-Board Power Supply 67

USB Ports..... 68

SD Card Slot 68

PREPARING FOR DRIVING

Activating Infotainment System..... 72

Main Interface 73

Vehicle Settings 75

Media Centre..... 75

Bluetooth Phone 75

File Manager 75

DRIVING

Getting to Know the Instrument Cluster
..... 78

Instrument Cluster Overview 78

Instrument Cluster Control..... 80

Adjusting Instrument Cluster Brightness . 81

Instrument Cluster Warning Lights/
Indicators..... 82

Pulling Out of Parking Spaces 86

Starting the Vehicle 86

Switching Driving/Terrain Modes 86

Switching to Steering Assist 87

Shifting Gears..... 88

Electronic Parking Brake (EPB) 89

Automatic Vehicle Hold (AVH)..... 90

Vehicle Speed Control 91

Brake/Accelerator Pedal..... 91

Light Control..... 91

Exterior Lights 91

High Beam Assist (HMA) 94

Wipers Control 95

Front Wipers Control 95

Rear Wiper Control..... 96

Driving Assist 97

Intelligent Cruise Control (ICC)* 97

Adaptive Cruise Control (ACC)..... 98

Lane Keeping System (LKS)* 102

Lane Departure Warning System (LDWS)104

Blind Spot Detection (BSD) 105

Traffic Sign Recognition (TSR)* 107

Predictive Emergency Braking System
(PEBS) 108

Safety Assist 111

Integrated Power Brake (IPB) 111

Airbags 116

Tyre Pressure Monitoring System (TPMS)
..... 121

Driving in Harsh Weather 122

Driving in Fog 122

Driving in Rain..... 122

Driving in Hot Weather 123

Driving in Cold Weather 123

Trip Record 124

Dashcam..... 124

In-Vehicle Camera 125

10km/h Speed Lock 126

Speed Sensing Auto Lock 126

Regenerative Braking 126

0-100 km/h: Full Throttle Experience
..... 126

PARKING

Side Mirror Auto-Tilt	130
Park Assist	130
Panoramic View	131

EXITING

Getting Ready to Exit	136
Closing Windows	136
Closing Sunroof	136
Powering Off	136
Unlocking from Inside	136
Auto Unlocking	136
Unlocking with the "Unlock" Button.....	136
Unlocking with the Interior Door Handle	137
Exiting Courtesies	137
After Exiting	137
Open Window/Sunroof Alarm	137

CHARGING

Charging Instructions	140
Charging Port.....	143
Charging Port Lock.....	143
AC Charging	144
AC Charging with Household Charging Equipment.....	144
AC Charging with Charging Pile Charger	145
Scheduled Charging	145
DC Charging	146
Smart Charging.....	146
Compatibility of Vehicle and Charging Infrastructure	147

LOCKING

Locking from Outside	150
-----------------------------------	------------

Remote Control Key.....	150
Locking with the Microswitch	150
Locking with the Interior Boot Lid Switch	151
Locking with the NFC Key Card*	151

Anti-Theft Alarm..... 151

Folding/Unfolding Side Mirrors..... 152

Manual Folding/Unfolding	152
Auto Folding/Unfolding.....	153

Lighting after Exit & before Entry 153

Headlights after Exit.....	153
Headlights before Entry	153

MAINTENANCE

Regular Maintenance..... 156

Maintenance Schedule.....	156
---------------------------	-----

Cleaning the Vehicle

Exterior Cleaning.....	159
Interior Cleaning.....	160

Exterior Maintenance

Waxing the Vehicle.....	161
Paint Maintenance	161

Interior Maintenance

Battery Maintenance

Maintaining the 12V Battery (Starter Fe Battery)	162
High-Voltage Battery Maintenance	164

Other Maintenance..... 166

Tyre Maintenance.....	166
Sunroof Maintenance	169
A/C System Maintenance	169
Replacing Wiper Blades	170
Anti-Corrosion Measures.....	171
Long-Term Parking.....	172

Refilling Fluids

Opening and Closing the Bonnet	172
--------------------------------------	-----

Refilling Windscreen Washing Liquid.....	173
Checking Coolant.....	173
Checking Brake Fluid.....	174
Replacing Fuses	175
Checking/Replacing Fuses	175
Fuse Distribution	176

EMERGENCY

Owner's Emergency	186
Unlocking/Locking	186
Power Boot Failure.....	187
Awakening Dormant 12V Battery (Starter Fe Battery)	187
Turning Hazard Warning Lights.....	188
Tools Included in the Vehicle	188
Wearing Reflective Vest	189
Using Warning Triangle	189
Inflating Tyres	189
Tyre Bursting/Leakage	191
Repairing Tyres.....	191
Jump Start.....	192
Emergency Starting	193
Towing	194
Vehicle support.....	196
Rescue.....	197
Vehicle Fire	197
Vehicle Flooding.....	197
Vehicle Collision	198

DATA COLLECTION AND PROCESSING

Vehicle Data Processing.....	200
Permanent Vehicle Transfer to Third Parties and Off-Line Mode.....	201
Disclosure of Personal Data to Authorities.....	202

Your Data Protection Rights	202
--	------------

VEHICLE INFORMATION

Vehicle Information.....	204
Vehicle Identification Number (VIN).....	204
Vehicle Nameplate and Label	204
Specifications	208
Vehicle Specifications	208
Motor	209
High-Voltage Battery.....	209
Wheels and Tyres	210
Brake System	211
Fluid Types and Usage	211

01

GETTING TO KNOW THE VEHICLE

Exterior	10
Interior	12

Exterior

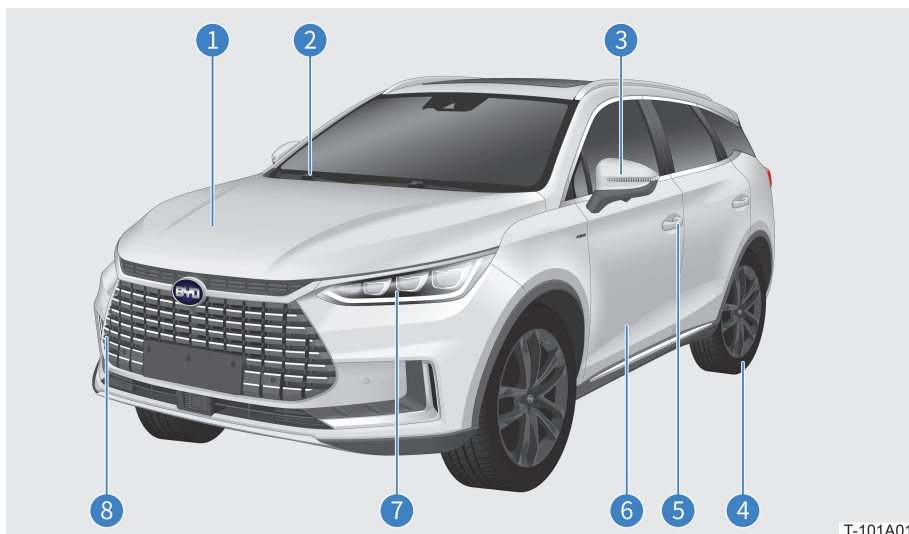

T-101A01

- | | | | |
|---|--------------------------------|---|-------------------------------------|
| 1 | Bonnet P172 | 5 | Exterior handle P36 |
| 2 | Front wiper P95/170 | 6 | Door P36 |
| 3 | Side mirror P52/130/152 | 7 | Headlight P93 |
| 4 | Tyre P166 | 8 | Front towing hook cover P194 |

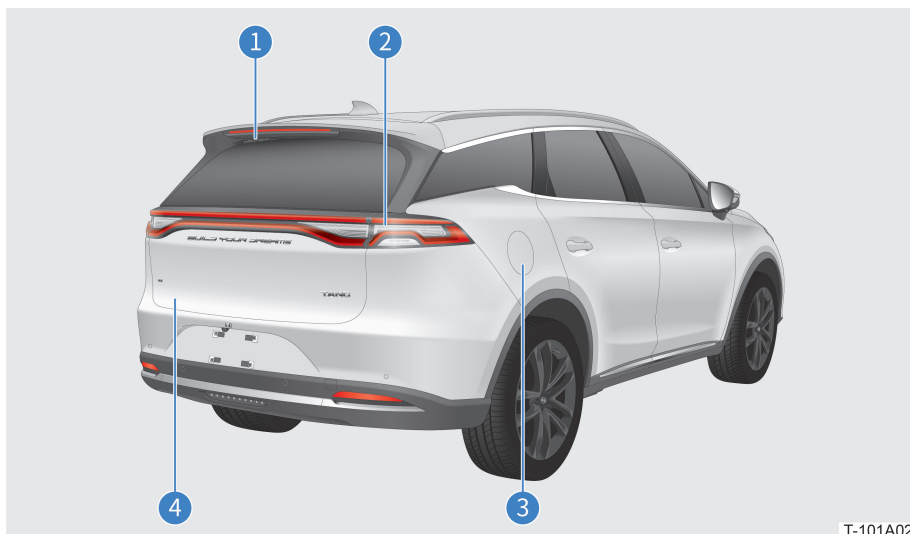

1 Rear wiper **P96/171**

3 Charging port **P143**

2 Rear combination light **P91**

4 Boot lid **P28**

Interior

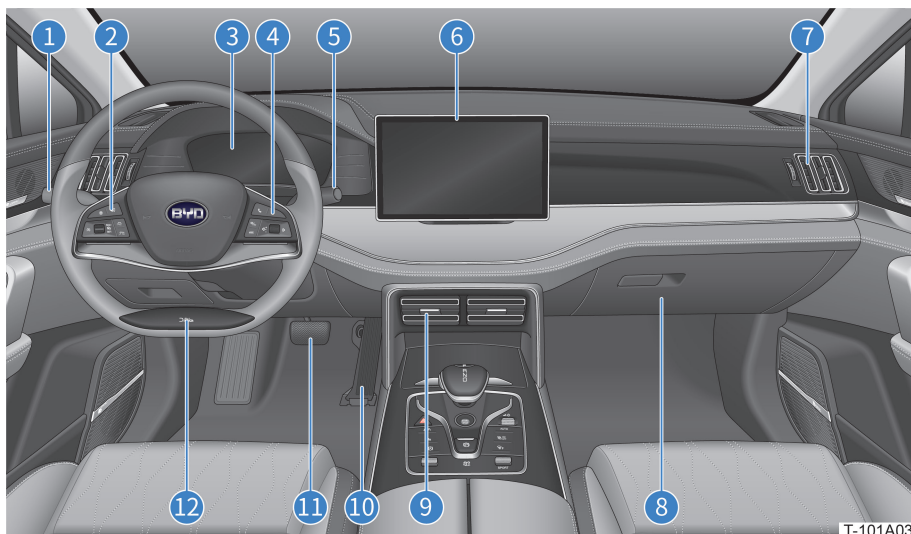

T-101A03

- | | | | |
|---|--|----|------------------------------|
| 1 | Light switch P91 | 7 | Front side vent P63 |
| 2 | Steering wheel left button P54 | 8 | Glovebox P26 |
| 3 | Instrument cluster P78 | 9 | Front centre vent P63 |
| 4 | Steering wheel right button P55 | 10 | Accelerator pedal P91 |
| 5 | Wiper switch P95 | 11 | Brake pedal P91 |
| 6 | Centre console touchscreen P73 | 12 | Steering wheel P53 |

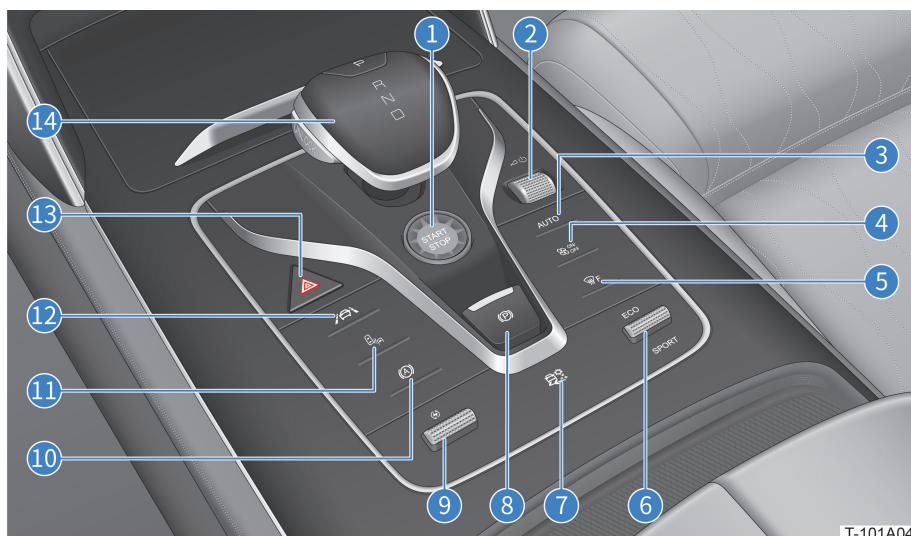

T-101A04

- | | | | |
|---|---|----|--|
| 1 | "START/STOP" button P47 | 8 | EPB switch P89 |
| 2 | Infotainment switch P72 | 9 | Regenerative braking mode switch P126 |
| 3 | Automatic A/C button P62 | 10 | AVH button P90 |
| 4 | A/C ON/OFF button P61 | 11 | BSD button P105 |
| 5 | Front windscreen defrosting button P62 | 12 | LKS button P102 |
| 6 | "ECO/SPORT" switch P86 | 13 | Hazard warning light button P188 |
| 7 | Snow mode button P87 | 14 | Gearshift lever P88 |

02 TRAVEL PREPARATION

Pre-Driving Inspection.....16

Pre-Driving Inspection

Before driving, it is recommended to:

- Check the tyres to ensure they are not damaged, pressure is not visibly insufficient, and that treads are free from foreign objects.
- Check the lights, windows and rear view mirrors to ensure they are clean and unobstructed.
- Check the front and rear wipers to ensure they are operating normally.
- Check underneath the vehicle for any leakage (except water from A/C condensation).
- Check vehicle surroundings to ensure there are no obstacles.
- Check SOC to ensure the high-voltage battery is sufficiently charged.
- Check the instrument cluster to ensure that all indicators are functioning properly.
- Check the seat belt to ensure that it is functioning properly.

03

UNLOCKING THE VEHICLE

Understanding the Keys.....	18
Locating the Vehicle	21
Unlocking	22

Understanding the Keys

This vehicle features three different types of key:

- Remote control key
- Mechanical key
- NFC key card*

Remote Control Key

Two remote control keys are provided with the vehicle. This key includes a mechanical key and a number plate.

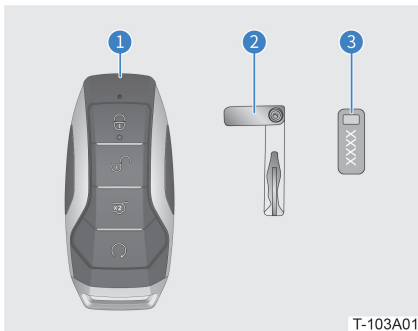

- 1 Remote control key
- 2 Mechanical key
- 3 Key number plate

The remote control key locks/unlocks the vehicle, opens/closes the boot lid and remotely powers on/off the vehicle.

The mechanical key is fitted inside the remote control key and can be used to lock/unlock the vehicle in case of emergency.

The key number plate is used to order spare mechanical keys.

! WARNING!

- Make sure to lock the vehicle and carry the key with you when leaving.
- Do not leave anyone unattended inside the vehicle (especially children), as this may result in adverse incidents.

! CAUTION!

- Keep the remote control key away from extended exposure to high or low temperatures as it is an electronic component. Such exposure may adversely affect its functionality.
- Keep the remote control key away from metal or magnetic materials to prevent its functionality from being affected.
- Protect the remote control key from falling or strong impact to prevent damage to its internal structure.
- Do not disassemble the remote control key without authorisation, as this may damage it.
- Keep the vehicle keys safe. If the remote control key is lost, contact a BYD authorised dealer or service provider as soon as possible to prevent theft.
- Do not change the key's transmission frequency, increase its transmission power (such as adding frequency amplifiers), add an external antenna or replace the antenna without prior authorisation.
- Avoid harmful interference with legal radio communication services while using the remote control key. Once any interference is identified, stop using the key immediately.

⚠ CAUTION!

- Owners with cardiac pacemakers or defibrillators should keep away from the PEPS (Passive Entry & Passive Start) system antenna, as the electromagnetic waves may interfere with such devices.

! REMINDER

- When the vehicle is locked and the remote control key is within detection range, its indicator will flash continuously.
- The remote control key indicator flashes when its buttons are pressed.

Functions of Key Buttons

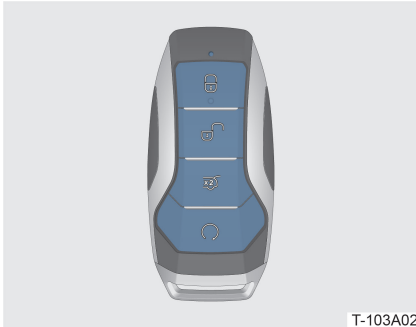

Locking button

Locks the vehicle, locates the vehicle and raises the windows.



Unlocking button

Unlocks the vehicle and lowers the windows.



Boot lid button

Opens and closes the boot lid.



Remote start/stop button

Starts and powers off vehicle.

Mechanical Key

If the mechanical key is needed, take it out as follows:

1. Slide the unlock clasp (1), pull the clasp out (2) and then up (3) to separate the bottom shell from the remote control key.

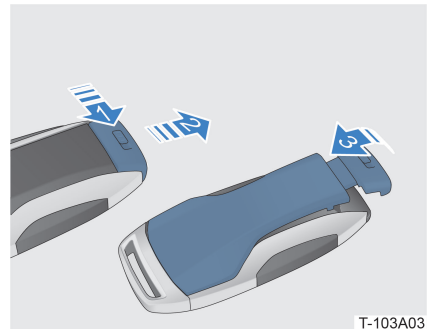

2. Take the mechanical key out and slide up its latch for use (refer to the **Emergency - Owner's Emergency - Emergency Unlocking/Locking**).

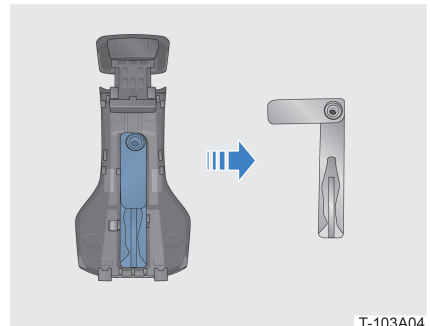

3. To put away the mechanical key, follow

the aforementioned procedure in reverse.

⚠ CAUTION!

- After using the mechanical key, put it back into the remote control key as soon as possible to avoid losing it.

Key Number Plate

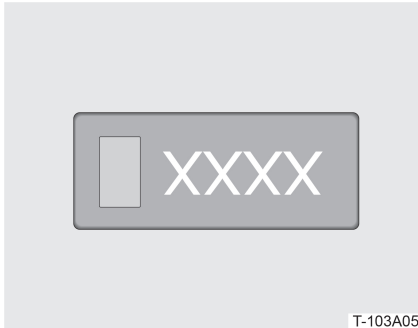

If the mechanical key is lost or a spare key needs to be made, it is best to entrust a BYD authorised dealer or service provider to make a mechanical key with the use of the key number plate.

⚠ CAUTION!

- Please keep the key number plate in a safe location.

Replacing the Remote Control Key Battery

The remote control key battery SOC will decrease even when the key is idle. The following circumstances indicate that SOC may be exhausted and the battery should be replaced as soon as possible.

- The remote control key is not working properly;
- The detection area of the remote control key has become smaller;

- "Low key battery" is displayed on the instrument cluster.

Replacing the remote control key battery:

1. Remove the bottom shell.
2. Rotate the battery cover clockwise and remove it.

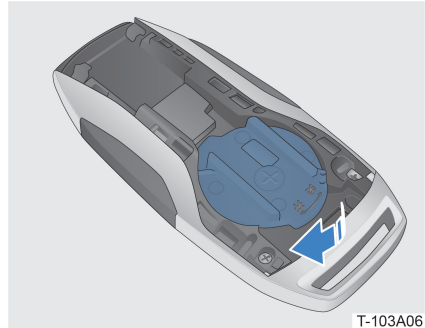

3. Remove the battery.

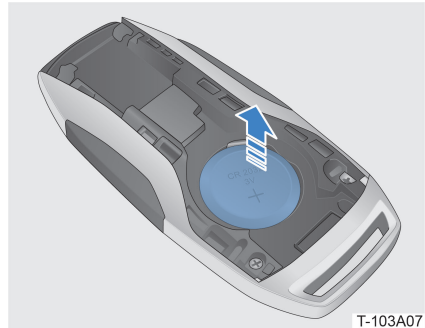

4. After replacing the battery, follow the aforementioned procedure in reverse to re-install the battery cover and the bottom shell.

⚠ CAUTION!

- Please keep the battery dry during replacement.
- The battery should only be held lightly by its edges when being inserted. Touching the battery's anode and cathode surfaces may shorten its service life.

REMINDER

- When installing the new battery, its anode (+) surface must face up.
- Battery model: CR2032.

SUSTAINABILITY

- Please dispose of waste batteries properly in an environment-friendly way.

Conserving remote control key SOC

When the remote control key is within 2 meters of the vehicle, there will be continuous communication between them through weak radio waves, which will reduce the key battery SOC more quickly.

If the remote control key is exposed to strong radio waves for extended periods, its SOC will run down more quickly, therefore, it must be kept at least one meter away from the following devices:

- Television sets;
- Personal computers;
- Smartphone chargers;
- Light stands;
- Fluorescent desk lamps.

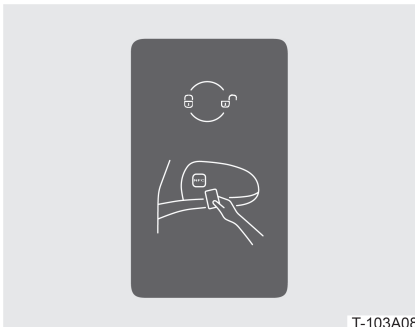
NFC Key Card*

T-103A08

The NFC key card locks and unlocks the vehicle.

CAUTION!

- Do not place the NFC key card in the charging area when the smartphone wireless charging function is activated.
- Do not attach the NFC key card to any object that may cut its electromagnetic signals, such as cellphone metal casings.
- Do not place the NFC key card where it is exposed to high temperatures, such as on top of the dashboard.
- Avoid bending the NFC key card.
- Do not store the NFC key card together with other hard objects.

Locating the Vehicle**With Remote Control Key**

When the vehicle cannot be found, this function is used to determine its location.



T-103A09



When the vehicle is in anti-theft mode and within the range of the remote control key signal, press the lock button . A beep will be heard and the vehicle's turning lights will flash, showing the vehicle's location.

Unlocking

The vehicle can be unlocked with:

- Remote control key
- Microswitch
- NFC key card*



! REMINDER

- Unlocking with the mechanical key is an unconventional unlocking method. For emergency unlocking with the mechanical key, refer to the **Emergency - Owner's Emergency - Emergency Unlocking/Locking**.
- The **Rear Mirror Fold** feature can be activated by tapping on  /  > **Vehicle Settings>External Mirrors** on the centre console touchscreen. After this function is activated, the side mirrors will automatically unfold when the vehicle is unlocked.
- When the vehicle is in anti-theft mode, all doors will automatically lock and re-enter anti-theft mode if none of them is opened within 30 seconds after being unlocked with the remote control key, microswitch or NFC key card*.



Remote Control Key



With the vehicle powered off, locked, and within the effective range of the remote control key signal:

- If the unlock button  is pressed, either the front left door or all doors will unlock simultaneously, the turning lights will flash twice, and the side mirrors will automatically unfold (if this function is activated).
 - » When the "unlock door with remote control key" feature is set as "driver side only" on the centre console touchscreen: press the unlock button once to unlock the front left door; press twice to unlock all doors.
 - » When the "unlock door with remote control key" function is set as "all doors" on the centre console touchscreen: press the unlock button once to unlock all doors.
- Press and hold the unlock button to unlock the vehicle and automatically lower the four windows. (The **Long Press Remote control key to Open Windows** feature can be activated by tapping on  /  > **Vehicle Settings > Doors, Windows and Lock** on the centre console touchscreen.)

! REMINDER

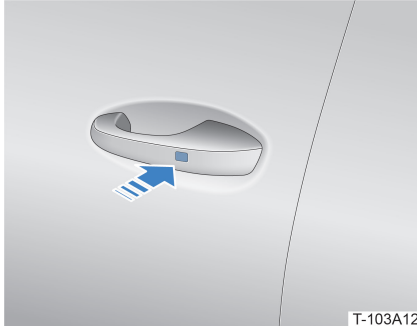

- Door unlocked with the remote control key can be set to be **Driver side only** or **All doors** by tapping on  /  > **Vehicle Settings>Doors, Windows and Lock>Remote Unlock** on the centre console touchscreen.

Microswitch



T-103A12

The Microswitch on the front door handles operates when the vehicle is locked, powered off, and the remote control key is within the front doors activation range:

- When the Microswitch is pressed, all doors unlock simultaneously, the turning lights flash twice, and the side mirrors unfold (if this function is activated).
- Press and hold the microswitch to unlock the doors and lower all the windows. (The **Long Press Switch to Lower Window** feature can be activated by tapping on  /  > **Vehicle Settings > Doors, Windows and Lock** on the centre console touchscreen.)

on the front left side mirror, all doors unlock simultaneously, the turning lights flash twice, and the side mirrors unfold (if this function is activated).

NFC Key Card*

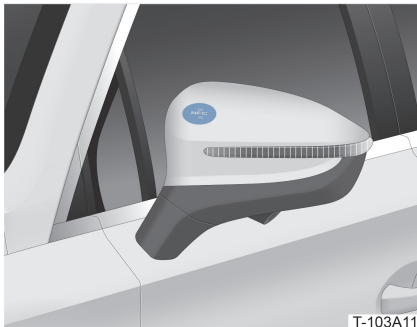

T-103A11

When the vehicle is powered off and the NFC key card is placed at the "NFC" mark

04

LOADING

Small Items	26
Luggage and Large Items	28

Small Items

This vehicle features several different spaces for convenient storage of small items.

WARNING!

- Make sure items kept in the vehicle will not disturb safe driving, especially when accelerating and braking.

CAUTION!

- When storing items inside the vehicle, beware of open liquid containers that might spill out while driving.

Interior Storage

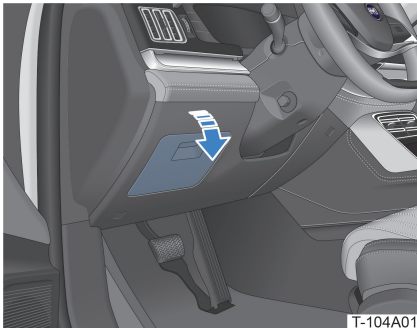

Driver's side glovebox

Pull the handle to open the driver's glovebox. Push the lid up to close.

WARNING!

- The driver's side glovebox should be kept closed when the vehicle is in motion so as not to affect safe driving.

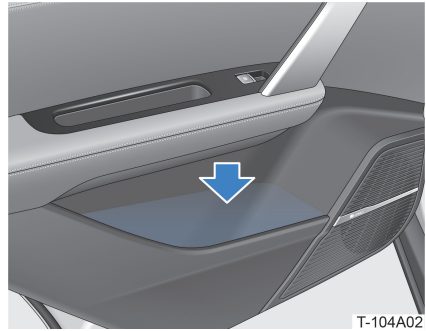

Door bins

The lower part of each door features a bin that can be used to store items like water bottles.

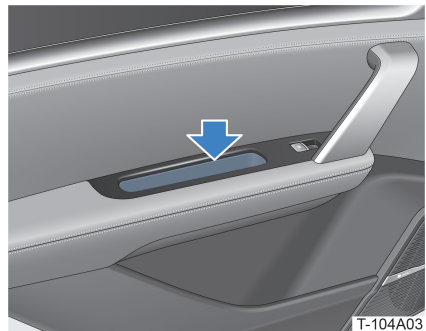

Door storage slot

Each passenger door features a storage slot for small items.

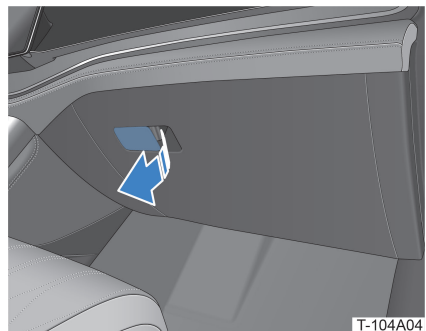

Glovebox

Pull the handle to open the glovebox. Push the lid up to close.

With the vehicle powered on:

- The glovebox light will go on when the glovebox is open, and go out when it is closed.

! WARNING!

- Keep the glovebox closed when the vehicle is in motion to prevent injury.



Front cup holder

Push the sliding closure forward to open the front cup holder.

Push the sliding closure forward again, and it will unlock and recoil to close.

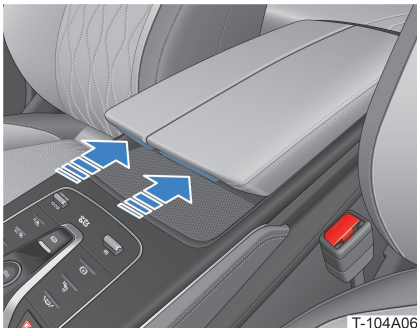

Centre console cubby

Press the front button of the centre console cubby cover and turn it outward to open.

Push the centre console cubby cover inward to close it.

! WARNING!

- Keep the centre console cubby closed when the vehicle is in motion to prevent injury.

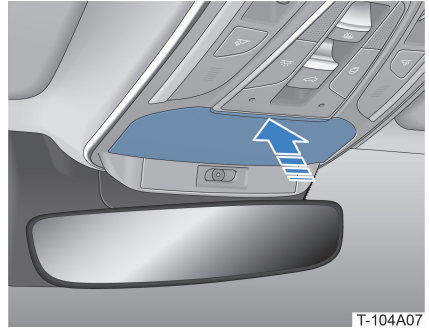

Sunglasses Niche

Press the cover to open, push the cover to close.

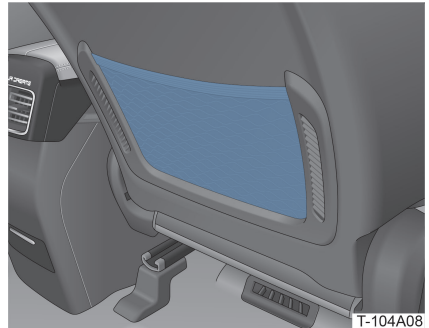

Storage bag

The back of each front seat has a storage bag to keep books, magazines, etc.



T-104A09

Second row seat storage box

1. Turn over the seat armrest.
2. Lift the cover to open the box.



T-104A10

Second row seat cup holder

Press the cover button to open, push cover down to close.



T-104A11

Third row seat cup holder*

There is a cup holder on each side of the third row seats.



T-104A12

Clothes hook

There is a clothes hook on the safety handle assembly.

! WARNING!

- Do not use the hooks to hang anything other than clothing, as these items may be ejected when the side curtain airbag is deployed, or hinder its deployment, resulting in personal injury.

Luggage and Large Items

Opening/ Closing Boot

With the vehicle in "Park" gear, the boot can be opened or closed by:

- Using the remote control key;
- Foot motion underneath the rear bumper;
- Using the internal boot switch;
- Opening the boot from outside;
- Closing the boot from inside;

If the vehicle is powered off, the boot can be opened from inside. Refer to **Emergency - Owner's Emergency - Emergency Unlocking/Locking** for details.

CAUTION!

- Make sure there is enough space to open the boot safely beforehand.

Opening/closing the boot with remote control key



Within the range of the remote control key signal:

- With the boot closed, double press the boot open/close button  on the remote control key to open the boot.
- With the boot opened, double press the boot open/close button on the remote control key to close the boot.
- While the boot lid is opening or closing, press the boot open/close button on the remote control key to stop its motion. Double pressing this button again will make the boot lid reverse its motion.

Foot motion underneath the rear bumper

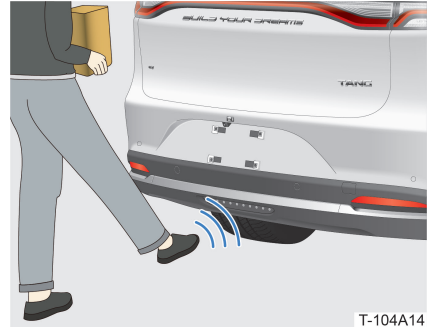

Keep the remote control key within the detection range (one meter), and move your foot underneath the centre of the rear bumper (do not touch the bumper). The boot lid will automatically open/close when the foot motion signal is detected.

If the foot motion signal is detected while the boot lid is opening or closing, the boot lid will stop its motion. If another signal is detected, the boot lid will begin reversing its motion.

WARNING!

- Maintain your balance when motioning your foot to activate the sensor.

CAUTION!

- When the remote control key is within range, the foot motion sensor may be triggered by any possible movement behind the vehicle, or when the vehicle rear is being serviced (e.g. polishing).

! REMINDER

- The foot motion must be under the centre of the rear bumper to trigger the sensor.
- If there is water or snow on the rear bumper, the motion sensor may have a delayed reaction. Once the water/snow is removed, the motion sensor will return to normal.
- When the boot lid is just about to close fully, there will be no response to the foot motion.

Opening/closing the boot with interior switch

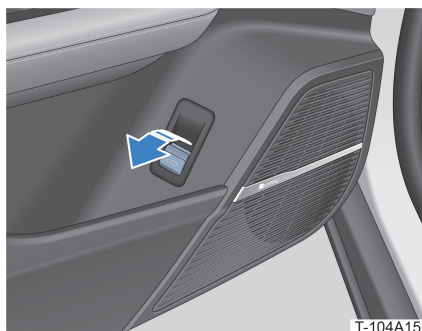

When the boot is closed, pull the interior boot switch  to open the boot. As the boot lid is opening, pull the switch again to stop its motion.

When the boot lid is open, pulling this switch and holding it for over 1s will close the boot automatically. Letting go of the switch will stop the boot motion.

Opening the boot from outside

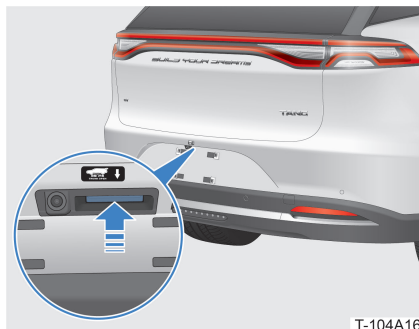



With the vehicle unlocked, press the external boot lid release button to open the boot.

With the vehicle locked, press this button while carrying the remote control key to open the boot.

As the boot is opening or closing, press the external boot lid release button to stop the boot lid motion. Pressing this button again will make the boot lid reverse its motion.

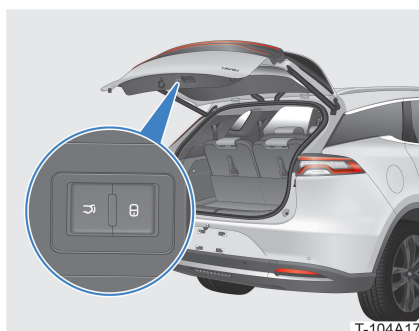
Closing the boot from inside



When the boot is open, press the close button  to close it.

As the boot lid is closing, press the close button to stop its motion. Tapping this button again will make the boot lid reverse its motion.

With the vehicle powered off and all doors

closed, press the lock button  while carrying the remote control key to close the boot lid and lock the vehicle. Anti-Theft mode will also be engaged.

Boot lid height settings

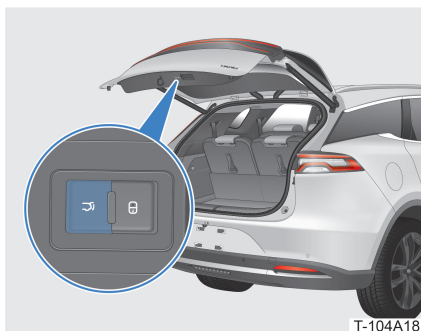

By default, the boot lid will open to its maximum height. The boot lid's height can be set as follows:

1. Open the boot lid and adjust its position to the desired height.
2. Press and hold the close button  on the boot lid and hold it for about 3s until a beep is heard, indicating that the boot lid opening height has been successfully set.



T-104A18

REMINDER

- Boot lid height can also be set via the centre console touchscreen. Select  /  > **Vehicle Settings** > **Doors, Windows and Locks** > **Boot lid Height** on the centre console touchscreen to set the percentage of boot lid opening.

Boot lid anti-pinch function

As the boot is opening or closing, the anti-pinch function will be triggered when the lid motion is obstructed by a large force. Should this occur, the lid will stop its motion.

WARNING!

- Do not intentionally activate the anti-pinch function.
- The anti-pinch function may not work when the boot lid is about to close fully.

Boot Light

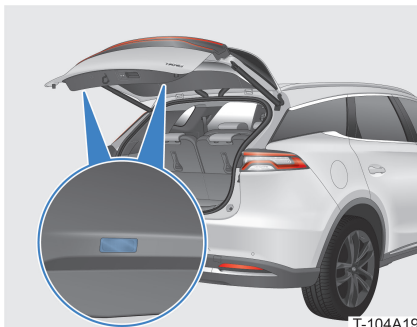

T-104A19

The boot light goes on automatically when the boot is opened.

The boot light goes out automatically when the boot is closed.

Luggage Lashing Eyes

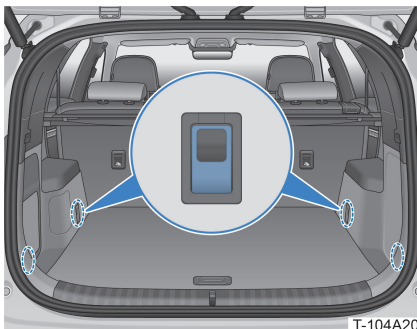

T-104A20

The boot is equipped with strap hooks to fasten luggage. To use these hooks, pull them down to fasten luggage or large items with straps or a net.

Luggage Compartment Cover*

Unfolding luggage compartment cover

The boot is equipped with a luggage compartment cover for privacy and shielding contents from direct sunlight.

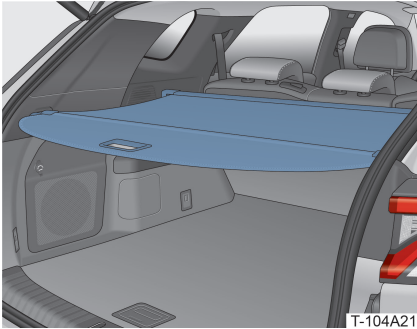

Pull the cover handle and secure the limiting posts at both ends of the curtain to the chute of the boot

Removing luggage compartment cover

The luggage compartment cover can be removed for space optimization.

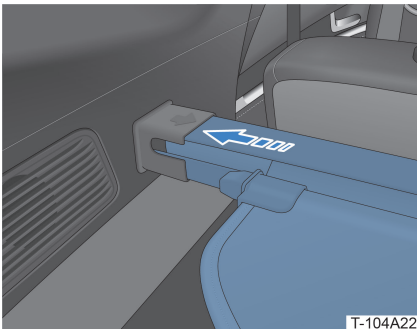

Push in one side of the cover assembly and remove it.

To reinstall it, simply follow removal

instructions in reverse.

! WARNING!

- Make sure that the luggage compartment cover is installed securely.
- Do not place any item on the luggage compartment cover.
- Prevent children from climbing onto the cover, as this may damage it and potentially cause physical injuries.

Folding Third Row Seats*

The backrest of the third row of seats can be folded completely forward to increase storage space. The seats can be folded as follows:

1. Press the headrest adjustment button (1) and push the headrest to its lowest position (2).

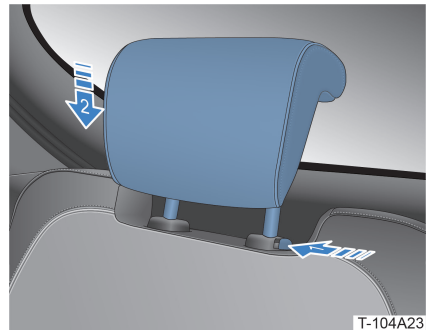

2. Fold the seat backrest.

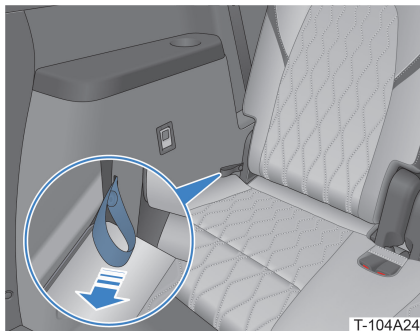

- Method 1:
 - » Pull the backrest unlocking strap and fold it.

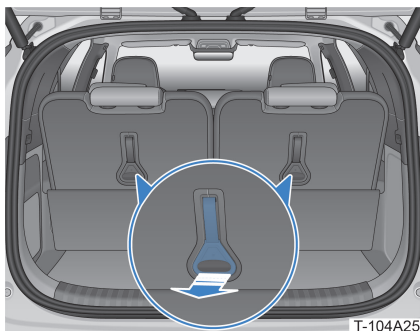

- Method 2:
 - » Pull the backrest unlocking handle and fold it.
3. Pull the backrest unlocking handle to unfold it.

Loading

Please heed the following when carrying loads:

! WARNING!

- The boot must always be closed when the vehicle is in motion. Failure to do so may result in serious or even life-threatening injuries.
- Do not exceed the maximum stipulated weight, otherwise, driving performance may be affected, posing a risk of traffic accidents, vehicular damage and personal injury.
- All luggage items must be securely accommodated in the boot so as not to affect driving safety.
- Passengers are not allowed to be carried in the boot.

! CAUTION!

- Do not load rough items in the boot without protection, so as to avoid scraping against the boot lid glass and damage to the heating element, which can result in damage to the rear windscreen defrosting system.
- Place heavy items in the front of the boot.
- Make sure there is ample space for the boot lid to open freely before opening it and loading items.

Roof Rack

Loading items on the roof increases the vehicle's centre of gravity, which interferes significantly in vehicle handling and steering performance. The following requirements must be observed for loading items on the roof rack.

CAUTION!

- Ensure that items loaded on the roof rack do not interfere with sunroof movement.
- Do not exceed the roof rack and overall vehicle load limit.
- Distribute the weight of the items evenly, and place the heaviest at the bottom.
- Fasten items firmly.
- Drive smoothly. Avoid sharp turns and sudden acceleration and braking.

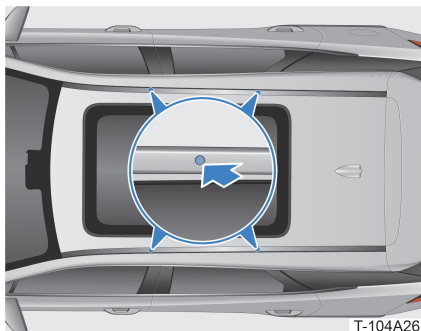

There are 4 mounting points on the roof rack to install a luggage carrier.

REMINDER

- When installing a luggage carrier on the roof rack, please strictly follow the manufacturer's installation instructions.
- The maximum load which can be evenly distributed on the roof rack is 50kg (including the weight of the roof rack itself).

05

WELCOMING AND GREETING

Opening Door.....	36
Welcoming.....	36

Opening Door

Exterior Handle

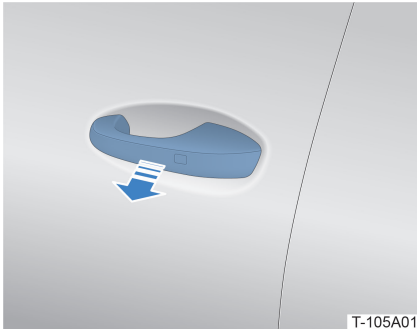

Unlock the vehicle and pull the exterior handle to open the door.



Welcoming

Exterior Welcoming

Exterior Lighting and Actions

When unlocked, the vehicle greets you by unfolding the side mirrors and flashing the turning lights twice.

! REMINDER

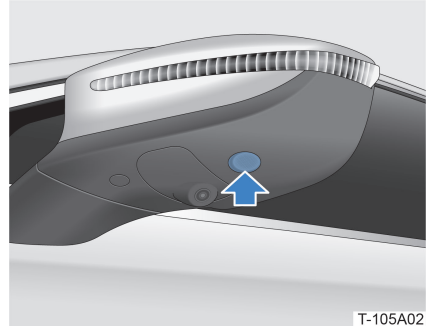

- The **Rear Mirror Fold** feature can be activated by tapping on  /  > **Vehicle Settings>External Mirrors** on the centre console touchscreen.

Smart Courtesy Light



When the vehicle is unlocked, the smart courtesy light will activate and then go out automatically after a while.

! REMINDER

- The **Smart Courtesy Light** can be turned on by tapping on  /  > **Vehicle Settings>Lights & Ambient** on the centre console touchscreen.

Door light

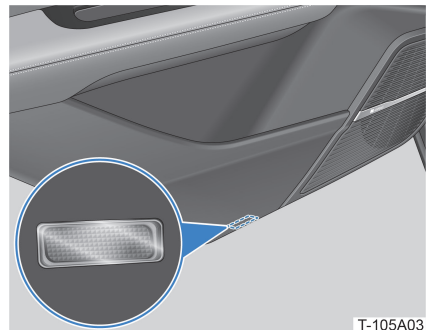

The door light goes on when the door is opened, and out when it is closed.

Interior Greeting

Smart Ambient Light

When the door is opened, the smart ambient light inside the vehicle will automatically go on to create a comfortable driving atmosphere.



The following can be set by tapping on / **>Vehicle Settings>Lights & Ambient** on the centre console touchscreen:

- Ambient light colour
- Ambient light brightness
- Ambient light area

Interior Lighting

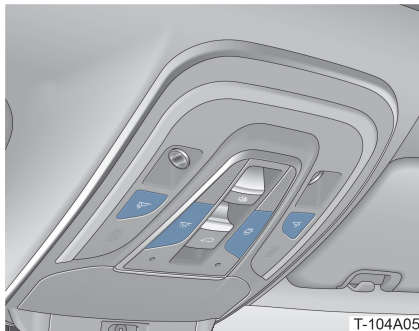

Left Reading Light Switch

Press the switch to turn left reading light on/off.

Right Reading Light Switch

Press the switch to turn right reading light on/off.

Interior Light Master Switch

Press the switch to turn interior lights on/off.

Door Control Button

Press the switch to activate/deactivate the Door Control feature.

With this function activated:

- The interior lights will go on when any door is opened.
- The interior lights will go out when all doors are closed.

Interior Greeting

The Greeting Mode can be activated by tapping on / **>Vehicle Settings>Welcoming** on the centre console touchscreen.

With the Welcoming feature activated:

- With the vehicle powered off, the steering wheel will retract when the front left door is opened, and the driver seat will move backward, making it more convenient to enter the vehicle.
- When the driver sits and closes the door, the steering wheel and driver seat will automatically return to their original positions.

06

RIDING

Child Safety	40
Seat Belts.....	43
Driving	47
Front Passenger Ride.....	57
Riding in the Second Row	57
Riding in the Third Row*	58
Comfort Ride	60

Child Safety

Riding Instructions for Children

Children's skeletal and muscular structures are not yet fully developed, and they are therefore more susceptible to being injured in an accident. To reduce the risk of injury, use a child safety seat when riding.

Warning labels on the front passenger sun visor and at the lower part of the left and right B-pillars remind you of the danger of the front passenger airbags.



Warning label on front passenger sun visor



Warning labels at the lower part of left and right B-pillars

! WARNING!

- Install the child safety seat according to the manufacturer's instructions. Failure to do so may cause serious or even life-threatening injury to a child during emergency braking, emergency turning or accidents.
- Riding with a child on one's lap does not replace the function of a child safety seat. Without the special seat, a collision may cause the child to hit the windscreen or any other part in the interior of the vehicle.
- In order to protect children effectively, choose a correct child safety seat based on the child's age, height and weight. The child should also be restrained and protected by a seat belt or child protection device.

Electronic Child Protection Lock

To prevent a child riding on the rear seat from accidentally opening rear doors, engage the child protection lock.



Press the button, the button indicator turns on, indicating the child safety lock function is activated. Opening rear doors from inside the vehicle and controlling rear windows with rear window switches are then both disabled.

Classification of Child Safety Seats (not provided with the vehicle)

Infant seats

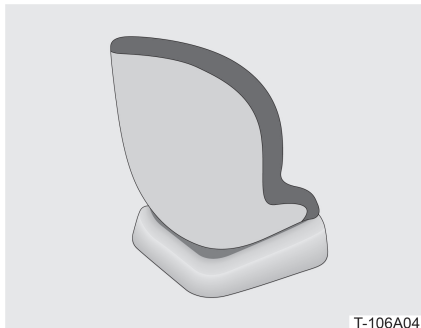

Infant seats cover Group 0 and Group 0+ child safety seats.

For infants aged under 2 and weighing less than 13kg, use infant seats that are adjustable to the lying position.

Toddler seats



Toddler seats include Group I child safety seats.

For toddlers aged under 4 and weighing between 9 and 18kg, use toddler seats which face forward or are equipped with seat belts.

Elevated seats

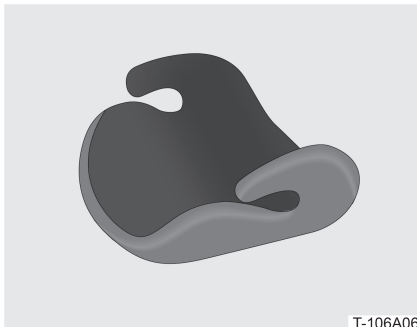

Elevated seats include Group II and Group III child safety seats.

For young children aged under 12 and weighing between 15 and 36kg, use three-point seat belts in combination with elevated seats.

WARNING!

- Please choose a suitable child safety seat for your child.
- Children who are too big to use a child safety seat should sit in the second row seat and properly fasten their seat belt.

Installing a Child Seat

ISOFIX

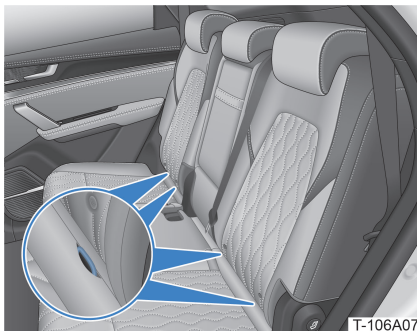

ISOFIX provides anchor points to tightly secure the child safety seat.

The anchors are located on the cushion of the second row seat.

LATCH

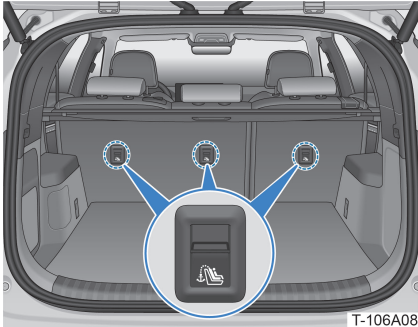

LATCH provides tether anchors to secure a child safety seat flexibly.

The tether anchors are located on the backrest of the second row seats.

Installing Child Safety Seat Equipped with ISOFIX

1. Move the corresponding front seat to the foremost position and adjust the seat backrest forward.
2. Place the child safety seat on the second row seat.
3. Secure the lower locking mechanism of the child safety seat to the ISOFIX anchors.
4. Try to push and pull the child safety seat in different directions to ensure it has been securely installed.
5. Reset and adjust the front seat.

! WARNING!

- When using ISOFIX anchor points, make sure that there are no foreign objects nearby and that the seat belt is not stuck behind the child protection device.

Installing Child Safety Seat Equipped with LATCH

1. Adjust the second row headrest to the highest position.
2. Pass the top strap of the child safety seat through the underside of the raised headrest, fasten it to the corresponding LATCH anchor, and tighten the top strap.

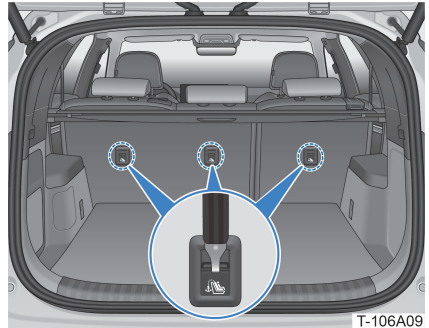

! WARNING!

- Do not lower the headrest after installing the child safety seat using LATCH. This is to prevent the headrest from touching the top strap and making it loose. The strap hanging loose can cause the child safety seat to rotate, resulting in serious injury in case of a collision.
- Do not connect multiple top straps to the same LATCH anchor.

Seat Belts

Protective Effect of Seat Belts

Vehicle, driver and passengers all have kinetic energy when the vehicle is in motion. The strength of this kinetic energy depends on speed, vehicle kerb weight, and the combined weight of all occupants. The greater the speed and combined mass, the stronger the energy released in a crash.

In the event of a collision, occupants without fastened seat belts will continue their motion forward at the speed the vehicle was going at the time of the collision due to inertia, whereas the vehicle will have come to an abrupt stop, potentially causing serious injuries to occupants.

In a collision in which the occupants have their seat belts fastened, the seat belts will restrain occupants to their seats and prevent them from being thrown violently forward or out of the vehicle. In addition, seat belts along with airbags provide the best protection, thus significantly reducing collision injuries.

WARNING!

- Forces acting upon the human body can be violent during a collision even if the vehicle speed is very low. Occupants who do not have their seat belts fastened may be thrown out of the vehicle, resulting in serious injuries.
- All occupants in the vehicle must properly fasten their seat belts. Failure to do so may cause them to be violently ejected from the vehicle in the event of an accident. This will not only cause personal injury but also endanger other occupants in the vehicle.

Correct Sitting Posture

For Driver



Correct driving posture is beneficial to driving operation and can reduce driver fatigue.

In order to ensure the safety of all occupants and reduce the risk of accident-related casualties, it is important for the driver to make the following adjustments:

- Adjust the position of the driver seat for easy and effective operation of pedals and control switches.
- Adjust the driver seat backrest so that the driver's back completely fits with the seat backrest.
- Adjust the driver seat headrest so that the driver's head is in the exact centre of the headrest.
- Adjust the steering wheel position so it is at a proper distance from the driver.
- Properly fasten the seat belt.

Front Passenger

In order to ensure front passenger safety and reduce risk of casualties, front passengers must make the following adjustments:

- Adjust the position of the front passenger seat to keep the occupant at a proper distance from the dashboard

panel.

- Adjust the occupant's seat backrest so that their back completely fits with the backrest.
- Adjust the occupant's seat headrest so that their head is in the exact centre of the headrest.
- Properly fasten the seat belt.

! WARNING!

- While riding, the front passenger's feet should be placed in the footwell under the dashboard panel. Front passengers must not rest their feet on the dashboard panel, or extend any part of their body out of the window or hunker down on the seat. This may cause personal injury in the event of emergency braking or accidents.

Other Passengers

In order to ensure the safety of other passengers and reduce risk of casualties, these passengers must make the following adjustments:

- Adjust the second and third row seat headrests so that the passenger's head is in the exact centre of the headrest.
- Maintain a correct sitting posture so that the passenger's back completely fits with the backrest.
- Properly fasten the seat belt.

! WARNING!

- While riding, the passenger's feet should be placed in the footwell in front of the second and third row seats. Passengers must not extend any part of their body out of the window or hunker down on the seat. This may cause personal injury in the event of emergency braking or accidents.
- When a child is in the second row, a corresponding child protection device must be used. Please refer to the **Ride - Child Safety** section.

Correct Use of Seat Belts

Wearing Seat Belts Correctly

All seating positions in the vehicle are equipped with three-point seat belts. The proper way to fasten the seat belt can be accomplished as follows:

1. Adopt the correct sitting posture.
2. Slowly and smoothly pull out the seat belt from the retractor, place over the chest and hips, insert the tongue into the buckle until a "click" sound is heard.

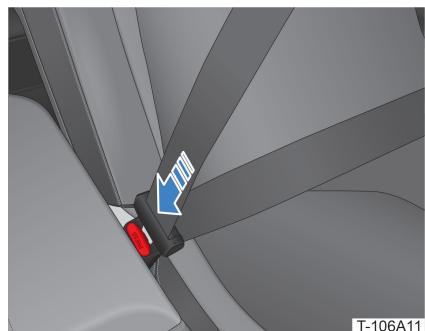

3. Pull the seat belt in the opposite direction and confirm that it has been successfully locked.

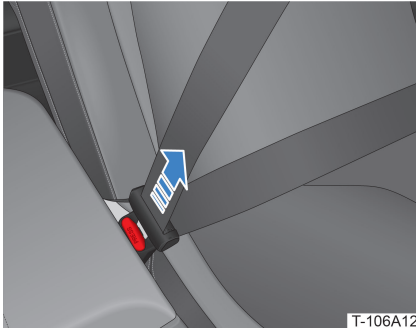

4. Adjust the position of the three-point seat belt.

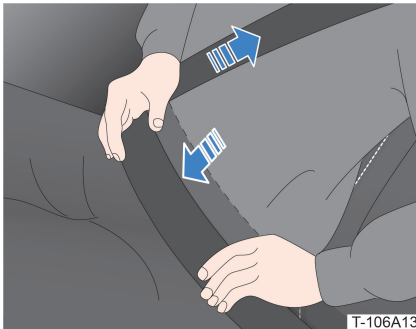

- Pull the shoulder strap so that it runs diagonally across the shoulder. Do not allow the shoulder portion across the neck or slip the shoulder off the belt strap.
- Wear the lap portion of the seat belt as low as possible across the hips.

! WARNING!

- Each seat belt must be used by one occupant only. Never share a seat belt with anyone.
- If the lap portion is too high or too loose, it may cause serious or even lift-threatening personal injury to drivers or occupants, for it may slip off in the event of an accident.

Unbuckling Seat Belts

1. Hold the seat belt and press the buckle red button. The tongue will pop up automatically.

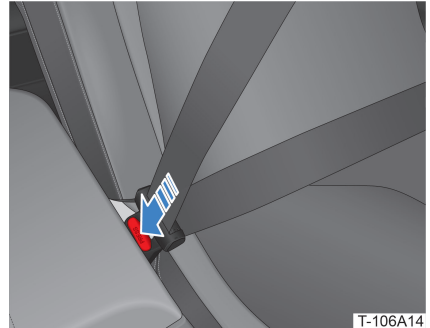

2. Slowly return the seat belt to the retractor.

! WARNING!

- Do not unbuckle the seat belt while driving or before coming to a complete stop, so as to avoid personal injury in the event of an accident.

! CAUTION!

- Be sure to smoothly retract the seat belt. If it cannot retract smoothly, it may be necessary to pull out the belt webbing to check for distortion or twisting.

Wearing Seat Belts When Pregnant

Women who are pregnant must pay attention not only to their own lives, but to that of their child. Therefore, pregnant women must be sure to properly wear their seat belt while driving or riding as a passenger.



Slowly and smoothly pull out the seat belt from the retractor, cross over the chest and hips. Ensure that the lap portion of the seat belt is as low as possible. Never fasten the lap portion over the abdominal area.

! WARNING!

- Never place anything between the occupant and the seat belt.

Adjusting Front Seat Belt Height

Seat belt height adjusters are provided on both the driver's and the front passenger's sides to ensure correct positioning of the seat belt. Adjust the seat belt height and let the shoulder portion of the seat belt pass roughly through the centre of your shoulder, away from the face and neck.

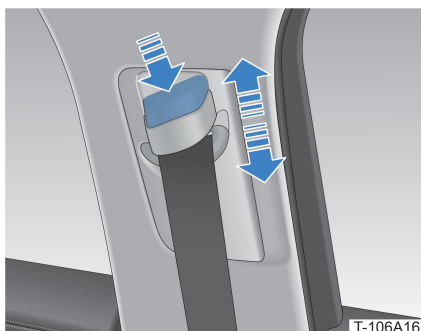

Adjust the seat belt height as follows:

1. Press the release button of the seat belt height adjuster.
2. Move it up or down to the desired height and release the button.
3. Check that it is locked into place by trying to move it without pressing the button.

! WARNING!

- Make sure the seat belt is properly adjusted and locked before driving. Failure to do so may jeopardize proper seat belt protection in the event of a collision.

Seat Belt Pre-Tensioner

The front seat and second row seat are equipped with pre-tensioner seat belts.

When the vehicle suffers a severe frontal collision and the activating conditions of the pre-tensioner are met, the pre-tensioner quickly retracts some of the seat belt and locks it to further protect the occupant. The pre-tensioner limits the restraint force the seat belt places onto the occupant's body within a certain range, so as to avoid any injury to the occupant caused by excessive restraint force.

! WARNING!

- The certified seat belt must be replaced if pre-tensioner function has been activated.

Seat Belt Reminder

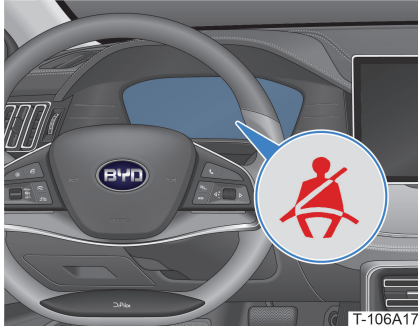

The vehicle is equipped with a seat belt sound reminder.

With the vehicle powered on, the seat belt reminder sounds an alert if the seat belt of any occupied seat in the vehicle is unbuckled.

Checking Seat Belt System

Check the seat belt system regularly:

- Always check if the seat belt reminder, seat belt, buckle, tongue, retractor and fixing devices are working normally.
- Check if the seat belt system is loose or damaged, and if there are any objects that may affect its normal operation.
- If the seat belt is cracked or worn, replace it immediately.
- Please keep the seat belt clean and dry.

Replacing Seat Belt System Components

If the seat belt system does not work properly, contact a BYD authorised dealer or service provider for repair. Do not use the corresponding seat before the seat belt is repaired.

Even if there is no obvious damage to the seat belt in case of a severe accident, the airbag system should be thoroughly inspected, and the seat belt should be replaced together with the seat assembly if necessary.

WARNING!

- Whenever it is necessary to replace a seat belt, a certified seat belt must be used.

Driving

Description of Power Status



With the remote control key inside the vehicle, press the brake pedal and START/STOP button to power on/off the vehicle.

When the vehicle is ON: The  indicator is displayed on the instrument cluster, all of the vehicle's electrical equipment is enabled, and it is ready for driving.

Driver Seat Controls

Adjusting the Seat

Adjust the driver seat to a safe and comfortable position using the seat control switches.

WARNING!

- Never adjust the seat while driving, to avoid losing control of the vehicle.

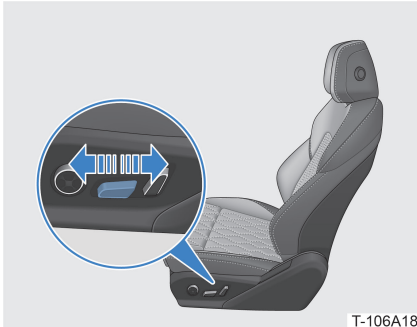

Forward/backward adjustment: move the position lever back and forth to slide the seat forward or backward.

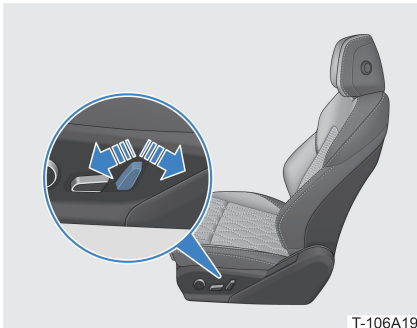

Backrest adjustment: toggle the backrest adjustment lever to adjust the backrest angle.

WARNING!

- Never tilt the seat backrest more than 30° when driving. Doing so may cause serious injury in the event of a collision.

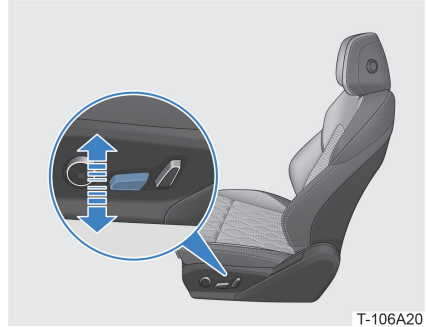

Cushion adjustment: toggle the front part of the driver seat position lever up and down to adjust the radian of the seat cushion.

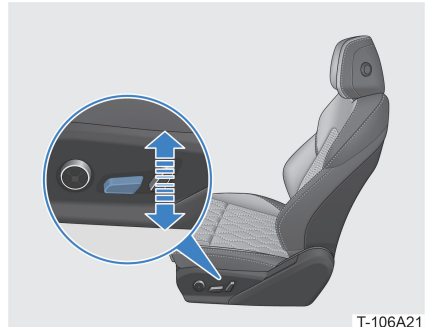

Height adjustment: toggle the rear part of the driver seat position lever up and down to adjust the height of the seat cushion.

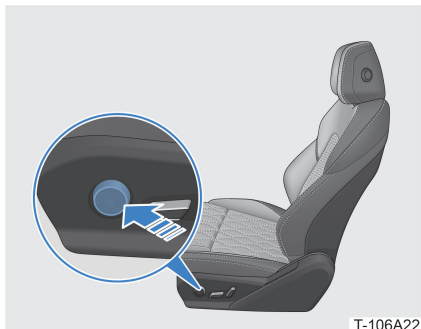

T-106A22

Lumbar support adjustment: press the front or rear part of the switch to strengthen or weaken the lumbar support; Press the upper or lower part of the switch to raise or lower the lumbar support.

! REMINDER

- The contour of the front seat backrest can be changed. The support can be adjusted according to the radius of the lumbar spine, so that the driver and the front passenger can sit correctly and comfortably.

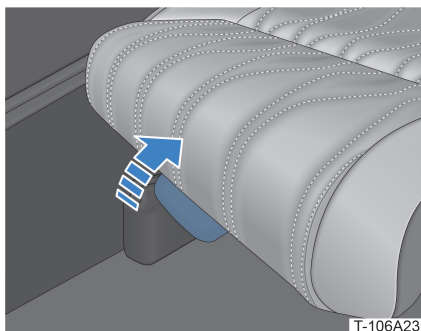

T-106A23

Leg support adjustment: pull the handle of the telescopic leg support under the seat, move the leg support forward/backward to a proper position, and then release.

! WARNING!

- The seat must be adjusted correctly to ensure that the brake pedal can be fully pressed. On this premise, the seat position should be as far back as possible to ensure a comfortable ride and make handling easier.

Seat Memory

Memory Button

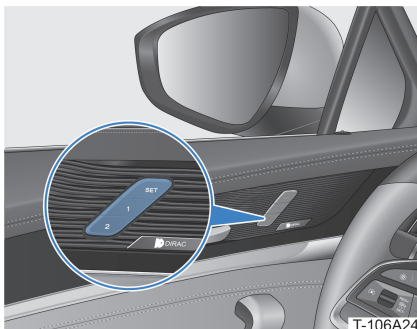

T-106A24

SET "Set" button

1 "1" memory button

2 "2" memory button

Setting the Seat Memory

When the vehicle is powered on and in "Park", set the seat memory function as follows after adjusting the driver seat, left/right side mirrors and the steering wheel to your desired positions:

- After pressing the "SET" button, press either "1" or "2" memory button within the next 3 seconds. The buzzer will then sound and show a prompt reading "position set".
- Press the "SET" button and either "1" or "2" memory button simultaneously. The buzzer will sound and show a prompt reading "position set".

! REMINDER

- When a new seat memory is set, any previous setting will be overwritten.

Awakening the Seat Memory

When the vehicle is in "Park", press the memory button "1" or "2" (if the memory information is set), and the driver seat, steering wheel and side mirrors will automatically adjust to the memorised position and angle.

Seat Heating and Ventilation

The front seats feature heating and ventilation functions.



To turn the heating/ventilation function on/off, pull down the **Quick Settings** menu or tap on the  button on the main interface of the centre console touchscreen to enter **Climate Controls > Vent/Heat**.



Driver seat heating



Driver seat ventilation



Front passenger seat heating



Front passenger seat ventilation

OFF Turn the heating/ventilation off

1 Low

2 High

! REMINDER

- Ventilation and heating functions cannot be turned on at the same time for a single seat.

Adjusting the Headrest

The front seat headrests feature four-way adjustment (up, down, forward and backward).

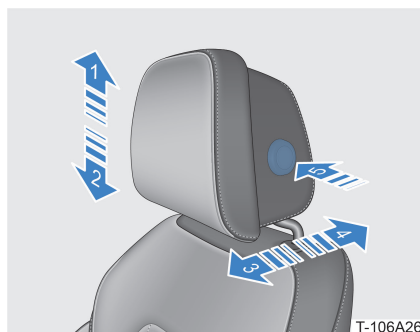

Raising the Headrest

Pull up the headrest to the desired position (1) and release. A "click" is heard when it locks.

Lowering the Headrest

Press the adjustment button on the left side of the headrest (5), lower it to the desired position (2), pull it up slightly and release button until a "click" sound is heard for locking.

Adjusting the Headrest Forward

Pull the headrest to the desired position (3) and release. A "click" is heard when it locks.

Adjusting the Headrest Backward

Press the adjustment button on the left side of the headrest (5), push it to the desired position (4), and release button until a "click" sound is heard for locking.

Removing the Headrest

1. Pull up the headrest to its highest position (1).
2. Press the adjustment button on the left side of the headrest (2). At the same time, insert a tool with less than 2mm diameter into the hole in the headrest base (3), and press it to unlock the headrest.

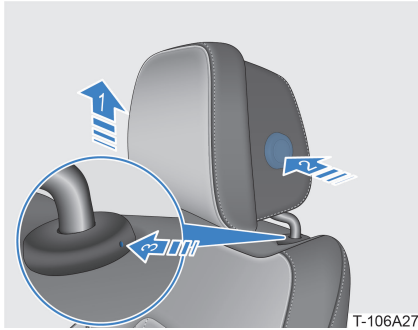

3. After successfully unlocking the headrest, pull it out.

Driver Window Control

Controlling the Driver Window



Window controls are enabled when vehicle is powered ON.

Manual Control

Press/ pull the switch to the corresponding

window to roll it up/ down to the desired position.

One-Touch Rolling Up/Down

Press/pull the switch to the corresponding window to its furthest position and release. The window will roll up/down completely.

As the window rolls up/down automatically, press/pull the switch to stop the motion.

! WARNING!

- Before closing windows, make sure there are no obstructions to its rolling so as to prevent physical injury.

Window Anti-Pinch

The anti-pinch function is triggered when the window is obstructed while closing. In such case, the window will stop and automatically roll down to some extent.

! WARNING!

- Do not intentionally trigger the anti-pinch function.

! CAUTION!

- The anti-pinch function may not work when the window is about to close completely.

Side Mirror Controls

Before driving, the side mirrors must be adjusted to a proper angle, so as to reduce blind spots and improve driving safety.

Adjusting Side Mirrors



 **Left side mirror button**

 **Right side mirror button**

 **Adjustment button**

When the vehicle is powered on, press the left/right side mirror button, and the corresponding button indicator will go on. Use the adjustment buttons to properly adjust the angle of the corresponding side mirror as needed.

WARNING!

- Never adjust the side mirrors while driving. Doing so may cause loss of vehicle control.

REMINDER

- This vehicle is equipped with double curvature side mirrors, which broadens the field of vision and reduces blind spots.
- Objects displayed in the side mirrors are closer than they may appear.

Folding/Unfolding Side Mirrors

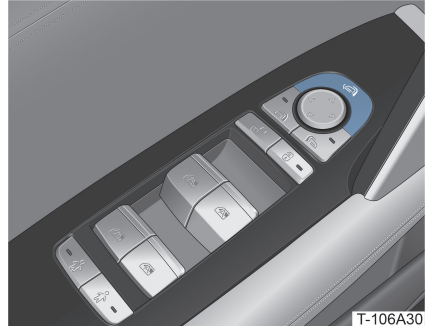

When the vehicle is powered on, press the  button to fold/unfold the side mirrors.

Please refer to the **Locking - Folding/Unfolding Side mirrors** section for how to operate the side mirrors.

Side Mirror Memory

Please refer to the **Ride - Driver Ride - Driver Seat Controls** section for how to operate the side mirror memory.

Heating Side Mirrors

Tap on the  button in the Climate Controls interface of the centre console touchscreen to turn on the side mirror heater and rear windscreen defroster.

If no further action is taken after the functions are activated, both will automatically turn off after working for 15 minutes.

Rear View Mirror Controls

Adjusting the Rear View Mirror

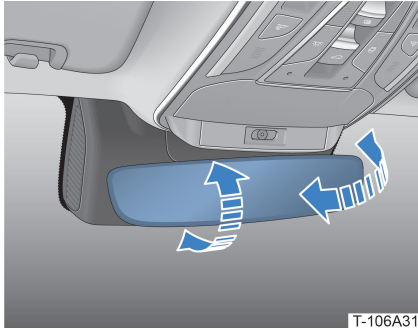

Manual adjustment: Adjust the position of the rear view mirror up/down/left/right according to your driving posture.

Automatic Anti-Glare

This vehicle is equipped with an automatic anti-glare rear view mirror. Its lens automatically adjusts the colour according to the surroundings. This helps reduce the interference of harsh light on your rear view.

Steering Wheel Controls

Adjusting the Steering Wheel

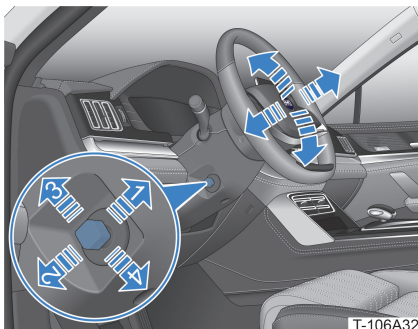

Toggle the adjustment switch (1) to extend the steering wheel.

Toggle the adjustment switch (2) to retract the steering wheel.

Toggle the adjustment switch (3) to tilt the steering wheel up.

Toggle the adjustment switch (4) to tilt the steering wheel down.

! WARNING!

- Never adjust the steering wheel while driving, as this may cause loss of vehicle control.

Steering Wheel Position Memory

Please refer to the **Ride - Driver Ride - Driver Seat Controls** section on how to operate the steering wheel position memory function.

Steering Wheel Heater

The steering wheel heater can be turned on/off by tapping on the  button on the main interface of the centre console touchscreen to enter the **Climate Controls > Vent/Heat**.

Steering Wheel Control Buttons



Left buttons



Panoramic View button

Press this button to turn the panoramic view on/off.



Screen Mode button

Press this button to switch between the "landscape" and "portrait" position of the centre console touchscreen.



Cruise Control OFF button

When the ACC system is active, pressing this button will put the system on stand-by.



Cruise Control button

Press this button to turn the ACC system on/off.



RES+/SET-

When the ACC system is on stand-by, toggle this switch upward to activate the ACC system and recall the previously set speed.

When the ACC system is on stand-by, toggle this switch downward to activate the ACC system and set the current speed as the cruise speed.



Distance Reduction button

When the ACC system is active, press this button to reduce the distance from the vehicle ahead. This function has four levels. Each press decreases one level.



Distance Increase button

When the ACC system is active, press this button to increase the distance from the vehicle ahead. This function has four levels. Each press increases one level.

Middle buttons



Horn pad

Press the pad to sound the horn.

Right buttons



Phone button

Press this button to make/receive a call (the infotainment system will be muted when making or receiving a phone call).

When the system is in a Bluetooth unrelated interface and Bluetooth is disconnected, press this button for the system to skip to the "Bluetooth Disconnected" interface. If Bluetooth is connected, press this button for the system to skip to the main dialing interface.

When a number is entered in the dialing interface, or an entry from the "Call History" or "Contacts" is selected, press this button to start dialing.

While under the main dialing interface with Bluetooth connected and no number input, press this button for the system to skip to the "Outgoing Calls" interface under the "Call History" interface. Press it again for the system to automatically call the first entry in the "Outgoing Calls" interface.



Instrument Cluster Menu/Return button

When there is no menu displayed, pressing this button will display the menu on the instrument cluster.

When the menu is displayed on the cluster, pressing this button will display the previous interface.

In the "Charging" interface, press this button to enter the "Scheduled Charging" interface.

In the "Scheduled Charging" interface, press this button to exit.

In the "Calls via Bluetooth" interface, press this button to end the call.

MODE button

MODE

Press the Mode button to switch among Music, Video, etc.

If the infotainment system is off, press this button to turn it on.



Right Roller

In the infotainment mode:

- Roll up to turn the volume up.
- Roll down to to turn the volume down.
- Press the roller to mute/unmute.

In instrument cluster menu mode:

- Roll up/down to adjust the menu.
- Press the roller to enter the menu next to the current option or confirm the current setting.

In the instrument cluster scheduled charging setting mode:

- Press the roller to confirm the current setting.



Left/Right buttons

In radio mode:

- Press the ◀ button to select the previous pre-saved radio station.
- Press and hold the ◀ button to automatically search for a radio station in the lower frequency direction.
- Press the ▶ button to select the next pre-saved radio station.
- Press and hold the ▶ button to automatically search for a radio station in the higher frequency direction.

In Music Player via USB/Bluetooth modes:

- Press the ◀ button to play the previous track (track listing -1).
- Press the ◀ button to select the previous entry in the "Bluetooth Call History" and "Contacts" interfaces.
- Press the ▶ button to play the next track (track listing +1).
- Press the ▶ button to select the next entry in the "Bluetooth Call History" and "Contacts" interfaces.

In instrument cluster menu mode:

- Press the ◀ button to switch the menu to the left.
- Press the ▶ button to switch the menu to the right.

In the instrument cluster scheduled charging setting mode:

- Press the ◀ button to switch the hour and minute settings leftward.
- Press the ▶ button to switch the hour and minute settings rightward.

Locking Doors from Inside



Press the  button to lock all doors.

Once doors are locked, the button indicator will go on.

Front Passenger Ride

Adjusting Seat

The front passenger seat features the following adjustments:

- Seat position forward and backward
- Seat backrest
- Seat lumbar support
- Seat leg support

The passenger seat adjustment method is identical to that of the driver seat. Please refer to the **Ride - Driver Ride - Driver Seat Controls** section.

Controlling Passenger Window

The passenger window control method is identical to that of the driver window. Please refer to the **Ride - Driver Ride - Driver window Controls** section.

Riding in the Second Row

Adjusting Seat

Adjusting seat position forward and backward

1. Pull up the adjusting lever.

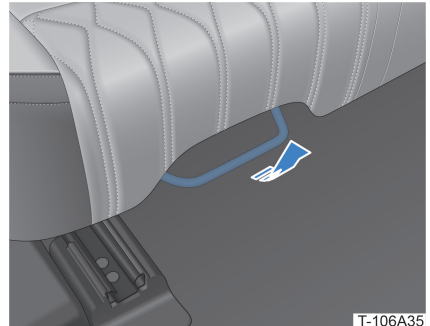

2. Slide the seat back and forth to the desired position and then release the lever.

REMINDER

- After forward/backward adjustment, try to slide the seat back and forth to ensure it is locked.

Adjusting seat backrest

Pull up the backrest adjustment lever, tilt the backrest forward/ backward to the desired position and release the lever.

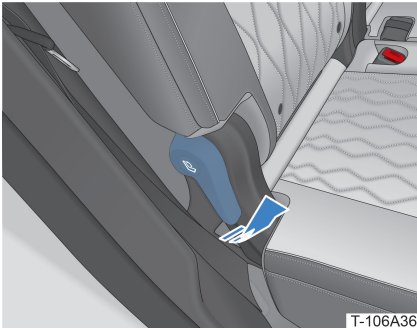

Adjusting Headrest

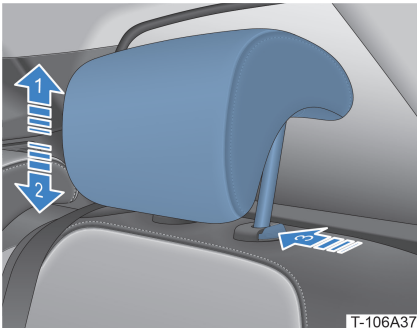

Raising Headrest

Pull up the headrest to the desired position (1) and release.

Lowering Headrest

Press the headrest height adjustment button (3), lower headrest to desired position (2) and release.

Removing Headrest

1. Pull up the headrest to the highest position (1).
2. Press the headrest height adjustment

button (3), pull out headrest (1) and release the button.

Installing Headrest

Insert the headrest links into the bushing with the groove facing forward. Press the headrest height adjustment (3), press the headrest to a proper position (2) and release.

Controlling Rear Windows

The rear window control method is identical to that of the driver window. Please refer to the **Ride - Driver Ride - Driver window Controls** section.

Second Row Lighting

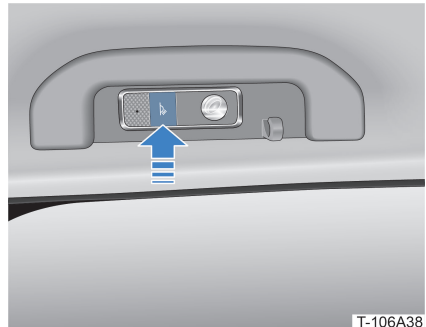

Press the  button to turn the interior light on the corresponding side on or off.

Riding in the Third Row*

Reaching Third Row Seats

Access to passengers riding on the third row seats is behind the second row right

seat:

1. Pull up the lever on the seat backrest and it will tilt forward.



2. Slide the seat forward for unobstructed access.





3. Slide the seat back and pull its backrest to its locked position.

Folding Seats

If additional storage space is necessary, the third row seats can be folded in. Please refer to the **Loading - Large Luggage Stowage - Folding Third Row Seats** section.

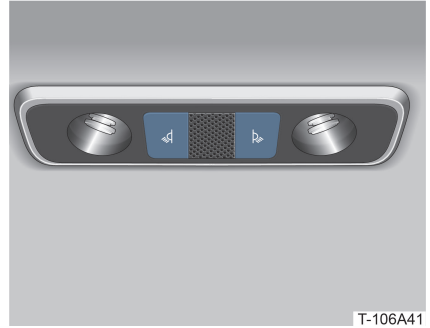
Third Row Lighting



Press the  button to turn the left rear interior light on/off.

Press the  button to turn the right rear interior light on/off.

Comfort Ride



A/C



- | | | | |
|---|----------------------------|----|---------------------------------|
| 1 | A/C ON/OFF | 8 | Recirculation |
| 2 | Auto A/C | 9 | Ventilation |
| 3 | Cooling | 10 | Driver Climate Control |
| 4 | Maximum Cooling | 11 | Negative Ion Mode |
| 5 | Dual-Zone Control | 12 | Blowing Mode |
| 6 | Front Windscreen Defroster | 13 | Blower Speed Adjustment |
| 7 | Rear Windscreen Defroster | 14 | Front Passenger Climate Control |

Climate Control

Manual Control

1. Start the vehicle.
2. Press the  button or tap on the  button on the Climate Control interface of the centre console touchscreen to turn on the A/C.



T-106A43

3. Select the A/C mode.



Cooling: A/C compressor on normal cooling mode.





Maximum Cooling: A/C compressor on maximum cooling mode, with top blower speed, and A/C in recirculation with face level vents.



Ventilation: only natural air is blown from the vents.

4. Adjusting A/C temperature.

- Slide driver/ front passenger controls up/ down or tap on the  /  button to set the A/C temperature.
- A "Hi" sign shows when the temperature is set to the maximum, and a "Lo" sign shows when it is set the minimum.
- **Dual-Zone Control:** when "DUAL" lights up, the driver/ front passenger A/C zoning is enabled, and when it goes out, the temperature at both

zones will change synchronously if adjusted.



REMINDER

- With the Dual-Zone Control mode disabled, operating the front passenger climate control will automatically switch the mode to DUAL.

5. Adjusting circulation mode.



Recirculation: only internal air circulates within the cabin.



External circulation: air from the outside is drawn in to circulate within the cabin.

6. Adjusting blowing mode.



Front Windscreen Vent: air is blown onto the front windscreen and side windows.



Face Level Vent: air is blown onto driver's and passengers' upper bodies.



Footwell Vent: air is blown onto driver's and passengers' feet.



REMINDER



- Blowing modes can be freely combined, and up to three blowing modes can be turned on simultaneously.

7. Adjusting blower speed.

- Blower speed can be adjusted from 1 to 7. To adjust blower speed, tap on the corresponding button on the touchscreen.
- Tap on the  button on the bottom left of the touchscreen to decrease

the speed, and on the  button on the bottom right of the touchscreen to increase the speed.

8. Turning off A/C.



- Press the  button or tap on the  button on the "Climate Controls" of the centre console touchscreen to turn A/C off.

Auto Control



Press the "AUTO" button or tap on the "AUTO" button on the Climate Controls of the centre console touchscreen to enter auto control mode.

In auto control mode, the A/C system automatically adjusts the blowing mode and blower speed according to the set mode.

Auto Control: To choose **Economic** or **Comfort** mode, tap on  /  > **Vehicle Settings > A/C > Auto A/C mode** on the centre console touchscreen.

A/C will exit auto control if:

- A/C is turned off.
- Blowing mode is switched manually.
- Blower speed is adjusted manually.

Remotely controlled A/C

When the remote control key is within the detectable signal range, press and hold the remote start key  outside the vehicle to start it and the A/C will automatically turn on. The A/C will automatically adjust

the temperature inside the vehicle to a comfortable level according to the ambient temperature.

After unlocking the vehicle or opening the door, the A/C settings will automatically return to the status before the last power-off.



REMINDER

- When SOC is lower than a certain value, the remotely controlled A/C feature is disabled.
- When the temperature inside the vehicle reaches the set temperature of the A/C, the A/C will intermittently stop cooling or heating, which is normal.

Front Windscreen Defroster

When frost or fog on the front windscreen and side windows affects the driving, front windscreen defroster function can be activated to defrost or defog and ensure safe driving.



Press the  button or tap on the  button on the "Climate Controls" interface of the centre console touchscreen to turn the front windscreen defroster on/off.

Rear Windscreen Defroster

Tap on the  button on the "Climate Controls" interface of the centre console touchscreen to turn the rear windscreen heater and defroster and side mirrors heater on/off.

If these functions are not turned off, they will turn off automatically after 15 minutes.

WARNING!

- Do not touch the rear windscreen and side mirrors when the defroster function is ON, for they will be hot and may cause burns.

Vents

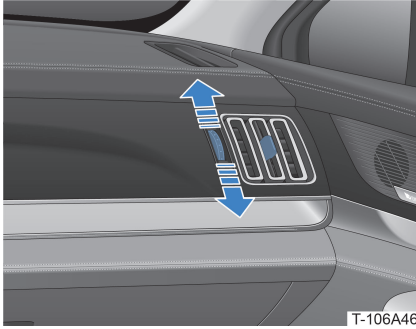

Front side vents

Scroll up/down to adjust air flow. Scrolling all the way up/down will fully open/close vents.

The vents angle can be adjusted by toggling the vent's center adjusting sheet.

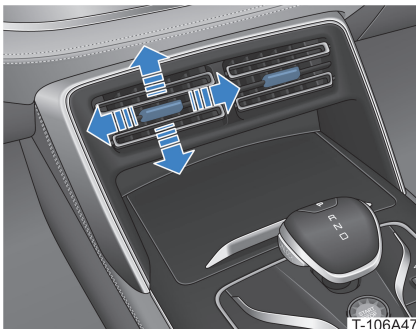

Front Centre Vents

The vents angle can be adjusted by toggling the vent's center adjusting sheet.

Slide the vent's center adjusting sheet to the left to close the vent.

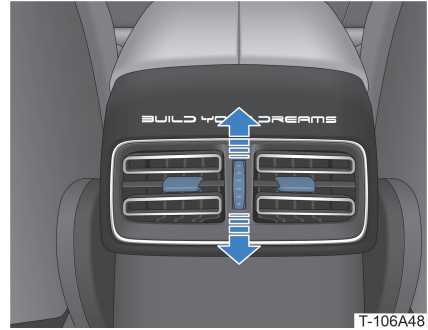

Second row Vents

Scroll up/down to adjust air flow. Scrolling all the way up/down will fully open/close vents.

The vents angle can be adjusted by toggling the vent's center adjusting sheet.

Air Purification

The air purification system cleans the air that is drawn into the cabin. It is activated when the A/C is turned on.



- 1 PM2.5 detection
 - 2 Quick purification
 - 3 Negative Ion
 - 4 Exterior PM2.5 value and level display
 - 5 Interior PM2.5 value and level display
- PM2.5 detection

» When turned on, the interior and exterior air PM2.5 values are detected and displayed on the centre console touchscreen in real time.

- Quick purification
 - » When turned on, the quick purifier and negative ion generator start working at the same time.
 - » When turned on/off, the quick purifier and negative ion generator start/stop working at the same time.

A/C System Settings

Tap on the "A/C Settings" button  on the "Climate Controls" interface of the centre console touchscreen to enter the A/C System Settings interface.

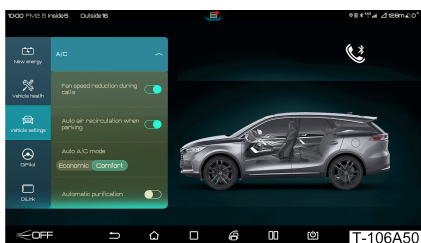

In the "A/C Settings" interface, the following functions can be set:

- Fan speed reduction during calls
- Decreasing blower speed while making calls
 - » When this function is activated, the A/C blower speed automatically decreases while a call is made via Bluetooth.
- Auto air recirculation while parking
 - » When the vehicle is in "Park" gear, this function switches the A/C to recirculation mode automatically.
- Auto control
 - » Auto A/C control features Economic and Comfort modes.
- Automatic purification
 - » Automatic purification can be turned on or off.

Panoramic Sunroof/Sunshade

Sliding to Open/Close Panoramic Sunroof

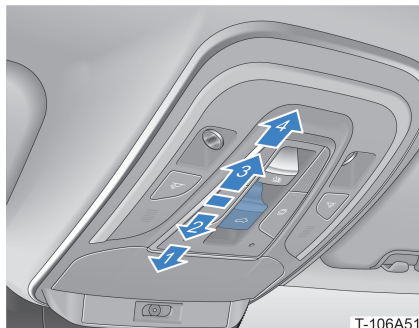

T-106A51

- **Manual opening/closing:** Push and hold the sunroof switch up/down (3)/(2) to open/close the sunroof. Its motion will stop when the switch is released.
- **Auto opening/closing:** The sunroof will automatically open/close completely when the switch is pushed to the furthest (4)/(1) and released. Pushing the switch again will stop its motion.

REMINDER

- The sunshade opens automatically along with the sunroof.

Tilting Panoramic Sunroof

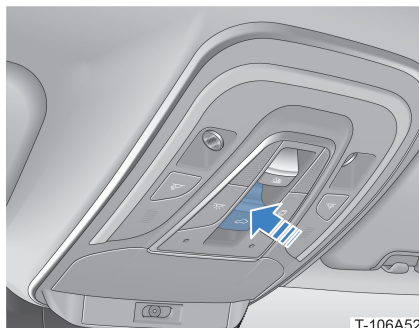

T-106A52

- **Manual tilting:** Gently press the rear end of the sunroof switch to tilt it. The sunroof stops in its current position when the switch is released.
- **Auto tilting:** Press the rear end of the sunroof switch to its furthest position and release. The sunroof will automatically tilt to the full opening angle.

Opening/Closing Sunshade

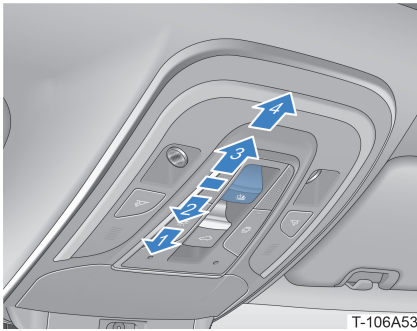

- **Manual opening/closing:** Push and hold the sunroof switch up/down (3)/(2) to open/close the sunshade. Its motion will stop when the switch is released.
- **Auto opening/closing:** The sunshade will automatically open/close completely when the switch is pushed to the furthest (4)/(1) and released. Pushing the switch again will stop its motion.

Sunroof/Sunshade Anti-Pinch

The anti-pinch function is triggered when the sunroof/sunshade is obstructed while closing. In such case, it will stop moving and automatically retract to some extent.

WARNING!

- Do not let anyone stick their head or hands out of the sunroof.

CAUTION!

- Operating the sunroof after rain or snow or after the vehicle has been washed may let water inside the cabin. Wipe it dry before operating.
- Opening the sunroof when it is covered in snow or ice may damage the sunroof and/or its motor.

Sun Visors

Using Sun Visors

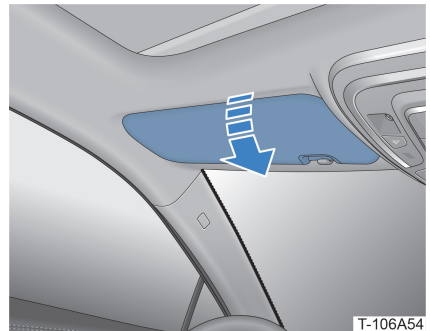

The sun visors are useful to shield the driver and front passenger from the glare of direct sunlight.

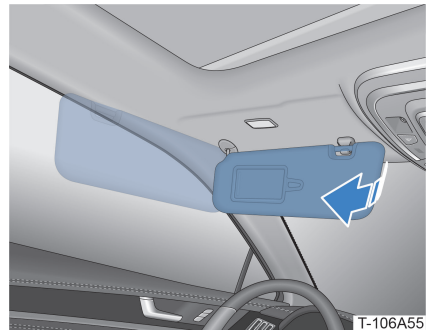

To shield from direct sunlight coming sideways, unhook the visor and turn it to the side.

Vanity Mirror and Light

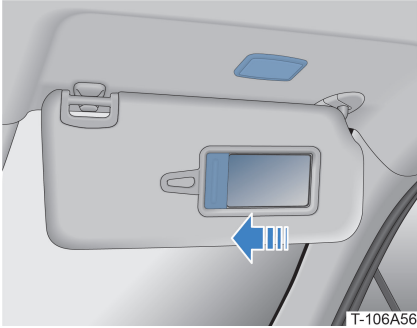

There is a mirror on the sun visor. Slide the cover to expose it.

- The overhead light will go on when the mirror cover is opened, and go out when it is closed.

Interior Roof Handle

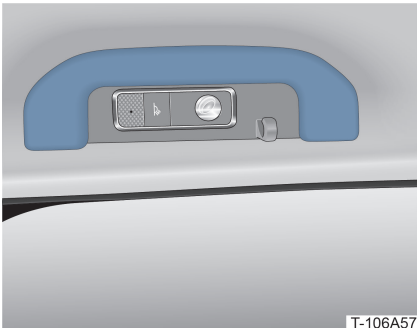

Passengers can maintain their balance by holding on to the roof handles while riding. The handles return to their original position once released.

CAUTION!

- Do not hang heavy objects from the handles.

Smartphone Wireless Charging

1. Start the vehicle.
2. Pull down the **Quick Settings** menu of the centre console touchscreen to light up the Wireless Charging icon.



3. Place the smartphone on the anti-skid rubber pad in the charging area, with its screen facing up. The smartphone then automatically begins wireless charging, and the charging icon is displayed on the centre console touchscreen.

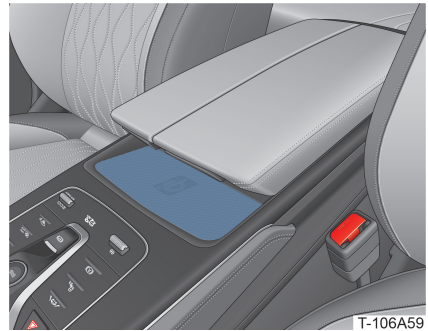

Charging: a green icon flashes.



Charging fault: a white icon flashes.

4. After use, turn off the wireless charging by tapping on the Wireless Charging icon in the pull-down Quick Settings menu of the centre console touchscreen. The Charging icon then disappears.

WARNING!

- Never use Wireless Charging while driving. Doing so may cause accidents.
- For safety concerns, do not leave devices charging unattended.
- Owners with pacemakers or defibrillators should first consult their physician about potential safety issues related to using wireless charging.
- Do not place metal items like keys or rings along with the smartphone while charging. Doing so may cause accidents.

CAUTION!

- In the event there is a failure with the smartphone wireless charging, it is recommended to contact a BYD authorised dealer or service provider.
- During wireless charging, ensure that the remote control key is more than 25cm away from the charging area.
- Credit cards or other magnetic objects should be kept away from the charging area to avoid demagnetisation.
- Do not use external wireless charging equipment.
- Do not place heavy objects in the charging area.
- Do not place a smartphone that exceeds the size of the wireless charging area.
- Do not spill any liquid in the wireless charging area.
- Do not disassemble or modify the wireless charging equipment.

REMINDER

- The smartphone wireless charging is applicable to Qi certified smartphones only.
- For better results, it is recommended that the smartphone's charging induction area is aligned with the centre of the wireless charging area (where the "Charging Area" is shown).
- Only one device can be charged at a time.
- If the phone case is too thick, wireless charging may be unsuccessful.
- When the vehicle runs through bumps, wireless charging may be briefly interrupted.
- If a door is closed while a device is being charged, charging may be briefly interrupted.
- When the vehicle is OFF and the driver is exiting, the instrument cluster will show a prompt reading "Please take your call phone with you".

On-Board Power Supply

The vehicle is equipped with a 12V on-board power supply in the centre console cubby and on the left side of the boot.

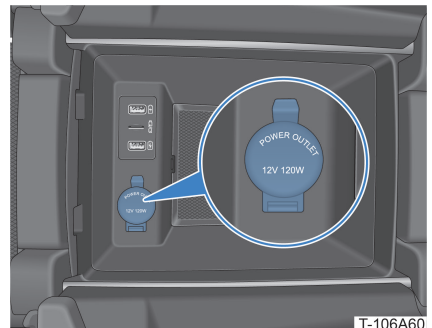

12V on-board power supply in centre console cubby

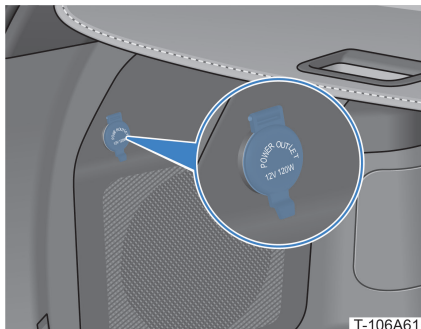

T-106A61

12V on-board power supply in boot

Lift the cover of the on-board power supply for use.

WARNING!

- Do not connect electrical appliances exceeding 120W into the 12V on-board power supply port.

CAUTION!

- When the 12V on-board power supply is not in use, keep its cover closed to prevent potential damage.

USB Ports

The vehicle is equipped with USB ports in the centre console cubby and below the rear vents of the second row seats.

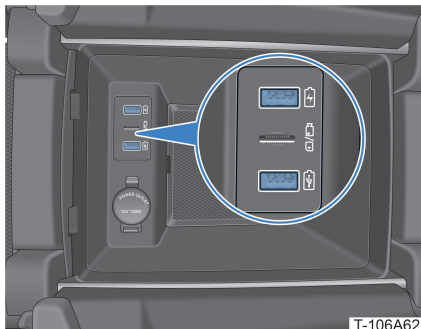

T-106A62

USB ports in centre console cubby



USB ports for data: charging and data transmission with electronic devices, such as smartphones.



USB ports for charging: only charging of electronic devices, such as smartphones.

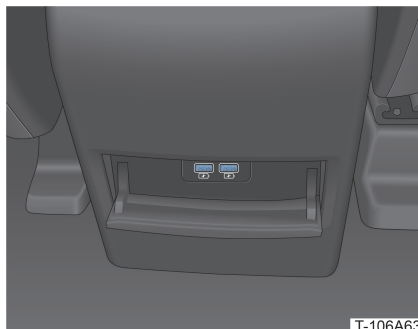

T-106A63

USB ports below rear vents

Rear USB ports can only be used for charging.

SD Card Slot

An SD card slot for trip recording is provided in the centre console cubby.

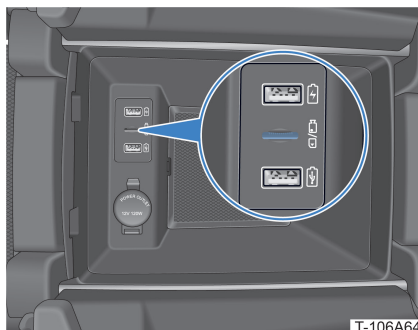

T-106A64

Insert the SD card and press it down to the bottom.

Remove the card by pressing it down and pulling it out.



CAUTION!

- Using an incompatible SD card may damage the vehicle infotainment system, SD card or data in the SD card.
- Use a FAT32-formatted SD card above 128G CLASS 10. Using other SD cards will affect the functionality of the dashcam.



REMINDER

- When the SD card is not inserted, encounters an error, or no readable file is found, a prompt reading "Insert micro-SD first" will be displayed on the touchscreen.

07



PREPARING FOR DRIVING

Activating Infotainment System	72
Main Interface	73
Vehicle Settings.....	75
Media Centre	75
Bluetooth Phone.....	75
File Manager.....	75

Activating Infotainment System

- The infotainment system automatically turns on when the vehicle is started.



- Press the infotainment system switch  or the "MODE" button on the steering wheel to turn on the infotainment system. Press and hold the  switch to turn it off.

Gesture and Response

The following actions can be carried out through the centre console touchscreen:

- Tap
 - » To open an app, choose a function, or enter characters, simply tap on the corresponding button on the touchscreen.
- Drag
 - » To move an icon to a new position, tap on and hold the icon and drag it to the target position.
- Slide
 - » Slide the screen up, down and sideways in the main interface or app interface.
- Double-tap
 - » Double-tapping can zoom in to enlarge the image to full screen.
- Spread Apart/Pinch Together
 - » Touch and hold an image with 2 fingers. To zoom in, spread them apart. To zoom out, pinch them together.

WARNING!

- Do not handle the infotainment system or view it frequently while driving. Driver's full attention must be on driving.
- Media player volume should be reasonable while driving so that the driver can hear any potential warning sounds from outside the vehicle. Failure to do so increases the risk of traffic accidents.

CAUTION!



- Please do not disassemble or modify the infotainment system, as this may cause system faults, fire, electric leakage, etc.
- Do not use sharp or edged hard objects on the screen, as this will damage it.
- Do not use any cleaning product to wipe the screen. Clean it with a damp soft cloth.

REMINDER

- The centre console touchscreen display interfaces shown in this manual are for reference only. The vehicle's actual display shall prevail.

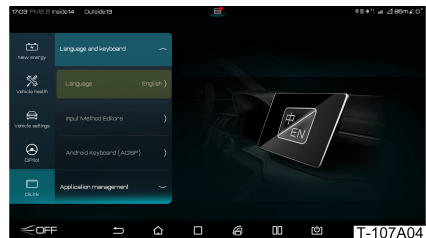
Language setting



When the vehicle is powered on, tap on  /  > **DiLink** > **Language and keyboard** > **Language** on the centre console touchscreen and set the language as Simplified Chinese or English.

Main Interface

Activate the infotainment system to enter the main interface.

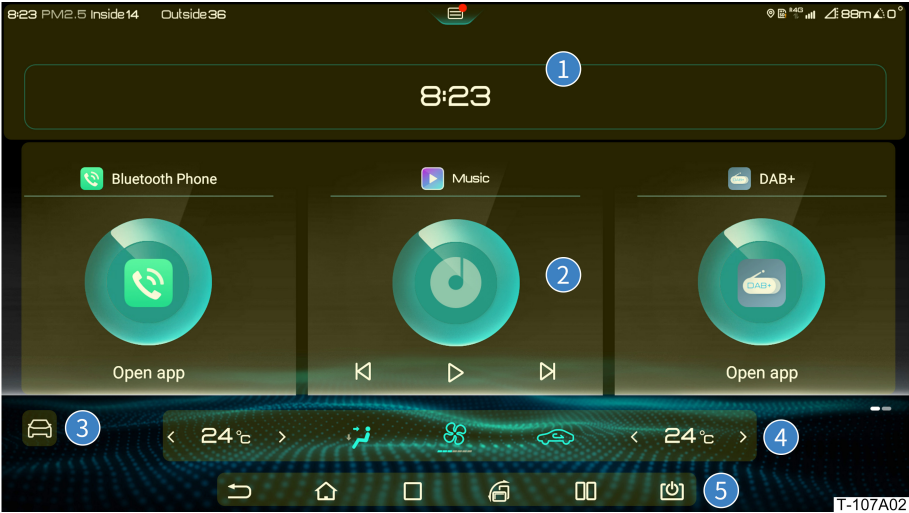

- 1 Top status bar
- 2 Smart card area
- 3 Vehicle Settings button
- 4 A/C shortcut bar
- 5 Bottom operation bar

Top status bar

Displays time, air conditions inside and outside the vehicle, Bluetooth, mobile data, signal strength and other information.

Tap on the  button to view push notifications. (A red dot indicates that there is a push notification)

Pull down to open the Quick Settings menu.



- 1 Management of Wi-Fi, Cellular data, Bluetooth and other functions.
- 2 Adjustment of backlighting, touchscreen and instrument cluster brightness, media player and voice volume.
- 3 Management of HMA, Charging, ESC OFF and other functions.
- 4 Management of Stereo, New Energy and Visor curtain functions.

Tap on the "Edit" box to enter the interface for control of all buttons contained in area 3. Drag the corresponding button icons to adjust the position of each shortcut button.

Tap on to turn Wi-Fi on/off. **Wi-Fi** can also be turned on/off by tapping on / > **DiLink > Connection**.

Tap on to turn Cellular Data on/off. **Network** can be turned on/off by tapping on / > **DiLink > Connection**.

Smart card area

Three shortcut cards can be set up:

- Adding a smart card:
 - » To edit the smart card, press and hold the smart card icon. The icon for the smart card that can be added will appear at the bottom of the interface. Drag it to the smart card area and release.
- Changing smart card position:
 - » Press and hold one of the smart card icons, drag it to the position of another smart card icon, and release.

Vehicle Settings button

Tap on the  button to enter the "Vehicle Settings" interface.

A/C Shortcut Bar

Adjusts A/C temperature, blowing mode and circulation mode.

Tap on the  button to enter the "Climate Control" interface.

Bottom operation bar

 : Returns to the previous page or exits the app.

 : Returns to home page.



 : Views recently opened apps.

 : Switches between "landscape" and "portrait" position of centre console touchscreen.

 : Views the apps in split screen.

 : Turns centre console touchscreen off while keeping the media player working.



Vehicle Settings

Tap on the  or  button on the main interface of the centre console touchscreen to enter the "Vehicle Settings" interface, including New Energy, Vehicle Health, Vehicle Settings, DiPilot and DiLink.

Media Centre

Tap on the  button on the main interface of the centre console touchscreen or press the **MODE** button on the steering wheel to enter the "Media Centre" interface, including Music, Video and Stereo.

Bluetooth Phone

Tap on the  button on the main interface of the centre console touchscreen or press the  button on the steering wheel to enter the "Bluetooth Phone" interface, including Dial, Contacts, History and Missed Calls.

! REMINDER

- When Bluetooth is not connected, the message "Bluetooth is Not Connected" will be displayed on the "Bluetooth Phone" interface. Connect a Bluetooth device first.
- Names of mobile devices ever connected can be stored in this interface. When the number of stored devices reaches the top limit, one of the names must be deleted before a new device can be added in.

File Manager

Tap on the  button on the main interface of the centre console touchscreen to enter the "File Manager" interface, including Recently used, All Files, Audio, Video and Image.

08

DRIVING

Getting to Know the Instrument Cluster.....	78
Pulling Out of Parking Spaces.....	86
Vehicle Speed Control	91
Light Control	91
Wipers Control	95
Driving Assist.....	97
Safety Assist	111
Driving in Harsh Weather	122
Trip Record	124
10km/h Speed Lock.....	126
Regenerative Braking	126
0-100 km/h: Full Throttle Experience	126

Getting to Know the Instrument Cluster

Instrument Cluster Overview

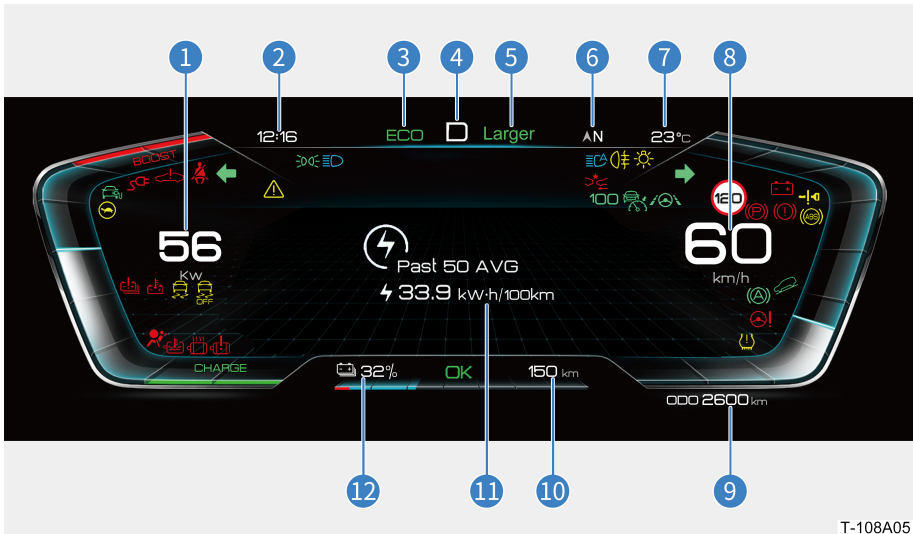

T-108A05



- | | | | |
|---|-------------------------------|----|--------------------------|
| 1 | Power meter | 7 | Ambient temperature |
| 2 | Time | 8 | Speedometer |
| 3 | Driving/Terrain mode | 9 | Odometer |
| 4 | Gear | 10 | Driving range |
| 5 | Energy regeneration intensity | 11 | Information display area |
| 6 | Orientation | 12 | SOC |

Power meter

Displays current vehicle power.

CHARGE displays power during regenerative braking.



! REMINDER

- The kW (HP) on the power meter may show a negative reading, indicating energy being gained through regenerative braking.
- Tap on  /  > **DiLink** > **Unit** on the centre console touchscreen to select either **HP** or **kW** as the power unit.

Time

Displays the current time.

! REMINDER

- The time can be either set by tapping on  /  > **DiLink** > **Time** on the centre console touchscreen or it can calibrate automatically via GPS.

Driving/Terrain mode

When the vehicle is in ECO/SPORT mode, the background of the instrument cluster and centre console touchscreen changes accordingly.

When the vehicle is in SNOW mode, the instrument cluster background changes accordingly.

! REMINDER

- The SNOW mode indicator  is displayed in the same position as the ECO/SPORT mode indicators.

Gears

Shows the current position of the gear shift.

Energy regeneration intensity

Shows the current energy regeneration intensity.

! REMINDER

- The **Larger** or **Standard** mode can be selected by tapping on  /  > **New Energy** > **Energy Regeneration** on the centre console touchscreen.

Orientation

Shows the current direction the vehicle is going.

Exterior temperature

Shows the current temperature outside the vehicle.

Speedometer

Shows vehicle current speed.

! WARNING!

- Make sure to abide by all traffic rules.

Odometer

Displays vehicle current mileage.

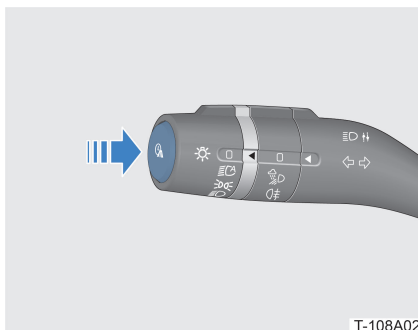

ODO/TRIP button

T-108A02

Press the "ODO/TRIP" button to switch between ODO, TRIP A, and TRIP B. The instrument cluster simultaneously displays all corresponding mileages.

When switched to TRIP A or TRIP B, press and hold the "ODO/TRIP" button to clear the corresponding trip information.

Driving range

Shows the estimated driving range based on the current battery SOC.

Display Range on Dashboard can be set by tapping on  /  > **New Energy > Energy** on the centre console touchscreen.

- **Standard:** range is displayed based on WLTP standard.
- **Dynamic:** range is displayed based on the battery SOC and the current average energy consumption.

! REMINDER

- In Dynamic mode, the driving range that is displayed after a full charge may vary according to calculations based on the energy consumption when the vehicle was last driven.
- In Standard mode, the driving range displayed on the instrument cluster is for reference only.
- The driving range may increase or decrease according to A/C, driving mode, and other conditions.

Information display area

Shows menus, driving information, faults, etc.

SOC indicator

Displays high-voltage battery state of charge from 0% to 100%.

- A blue bar displayed indicates fully

charged battery.

- When the SOC is below 10%, a red bar is displayed on the SOC indicator along with a text prompt on the instrument cluster reminding the driver to recharge.

! REMINDER

- Pay close attention to the battery SOC, as insufficient battery power can cause trip problems.

Instrument Cluster Control



Menu Information



The "Menu" interface allows for the adjustment of the following information:

- Speed limit warning: adjusts the speed limit that will cause the vehicle to give a warning.
- Temperature: adjusts the A/C temperature.
- Blower speed: adjusts the A/C blower speed.
- Driving information: views the driving information.
- Theme: switches the themes.
- Acceleration timer: enters the "Acceleration Timer" interface.
- Fault history: views fault information.

The vehicle can be adjusted as follows:

1. Press the  button on the right side of the steering wheel to enter the "Menu" interface.
2. Press the  or  button to select an option from the menu.
3. Roll the right roller to adjust the menu.
4. After adjustment, press the right roller to confirm the option have been selected from the menu and exit.

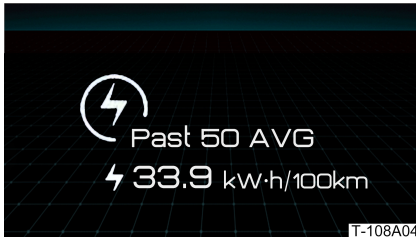

Driving Information



When there is no fault/operation prompt information on the instrument cluster, roll the right roller to select the "Driving Information" interface.

Driving information includes: driving range, energy flowchart, average accumulated energy consumption, average vehicle speed, driving time, average energy consumption for the past 50 km and tyre pressure.

! REMINDER

- The average energy consumption for the past 10, 25, or 50km can be viewed by tapping on  /  > **New Energy > Energy > Energy Consumption Curve** on the centre console touchscreen.

Fault Information



When the vehicle experiences a system fault or operation, the instrument cluster displays the fault/operation prompt information:



- When a fault prompt appears, it can be cancelled by pressing the right roller.
- An operation prompt disappears automatically after a few seconds.

! REMINDER

- Menus, driving information, faults and other information displayed on the instrument cluster vary depending on vehicle features. Check your own vehicle for the display.

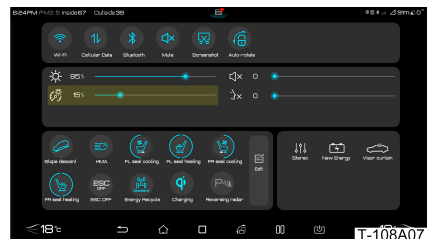
Adjusting Instrument Cluster Brightness



To adjust instrument brightness, pull down the **Quick Settings** menu or tap on the  /  > **Vehicle Settings > Display** to select **Vehicle/Instrument Brightness Adjustment** on the centre console touchscreen.

Instrument Cluster Warning Lights/Indicators

REMINDER

- When starting the vehicle, some indicators or warning lights light up for a short time, indicating that the system is carrying out a self-diagnosis. This is a normal inspection.

Turn Signals

If the left turning light is active, the left turn signal goes on.

If the right turning light is active, the right turn signal goes on.

If the hazard warning indicator is on, both the turn signals and all turning lights flash simultaneously.

Clearance Light Indicator

If on, it indicates that the front and rear clearance lights, the license plate lights, and some interior backlights are turned on.

Rear Fog Light Indicator

If on, it indicates that the rear fog lights are on.

AVH Indicator

 If on, it indicates that the automatic vehicle hold (AVH) function is enabled and standing by.

 If on, it indicates that the AVH function is enabled and functional.

AEB Indicator

 If on, it indicates that the automatic emergency braking (AEB) system is functional.

 If on, it indicates that there is a failure in the AEB system. Park safely and contact a BYD authorised dealer or service provider.

EPB Indicator

If it flashes, it indicates that the electronic parking brake (EPB) is being applied.

If on, it indicates that the EPB has been applied.

HDC Indicator

If on, it indicates that the hill descent control (HDC) function is enabled.

If it flashes, the HDC is functional.

ICC Indicator

If on, it indicates that the intelligent cruise control (ICC) system is enabled and functional.

ACC Indicator

If on, it indicates that the adaptive cruise control (ACC) system is enabled and functional.

OK Indicator

If on, it indicates that the vehicle is powered on.

ECO ECO Mode Indicator

If on, it indicates that the vehicle is in ECO mode.

SPORT SPORT Mode Indicator

If on, it indicates that the vehicle is in SPORT mode.

**SNOW Mode Indicator**

If on, it indicates that the vehicle is in SNOW mode.

**High Beam Assist Indicator**

If on, it indicates that the High Beam Assist system is enabled and functional.

**High Beam Indicator**

If on, it indicates that the high beam headlights are on.

**TSR Indicator**

If on, it indicates that the speed limit of the current road has been recognised.

**Charging Connector Indicator**

If on, it indicates that the charging connector has been inserted.

**ESC OFF Warning Indicator**

If on, it indicates that the Electronic Stability Control (ESC) system is off.

If it goes out, the ESC system is on.

**ESC Warning Indicator**

If on, a failure has occurred in the ESC system. Contact a BYD authorised dealer or service provider.

If it flashes while driving, it indicates that the ESC system is functional.

**Driving Power Limit Indicator**

If on, the driving power of the vehicle is restricted.

**Key Detection Indicator**

If the "START/STOP" button is pressed when the remote control key is not within range, this indicator is on along with a beep from the buzzer, "Key not detected: confirm key is within reach" is displayed on the instrument cluster. After the remote control key is brought into range, this indicator goes off.

If the "START/STOP" button is pressed when the remote control key is within range, this indicator flashes, indicating that the key battery is low. In the event of low key battery, replace the battery promptly (refer to **Unlocking Vehicle - Getting to Know the Key - Remote Control Key**) or proceed to emergency starting (refer to **Emergency - Owner's Emergency - Emergency Starting**).



ABS Fault Warning Indicator

If on, there is a failure in the Anti-lock Braking System (ABS). Contact a BYD authorised dealer or service provider.

If this indicator and the parking system fault warning indicator go on at the same time, it indicates that ABS has lost its function. Contact a BYD authorised dealer or service provider.



Main Warning Indicator

If on, a fault prompt is displayed in the driving information area. Contact a BYD authorised dealer or service provider.



Headlight Fault Warning Indicator

If on, it indicates that the headlights have failed. Contact a BYD authorised dealer or service provider.



TPMS Warning Indicator

If on, along with one or more figures shown on the tyre pressure display interface of the instrument cluster turning yellow, it indicates low pressure in one or more tyres.

If it goes on or flashes along with a prompt reading "Check the TPMS" displayed on the instrument cluster and a "--" instead of the associated figure(s) displayed on the tyre pressure display interface, it indicates a fault in the tyre pressure monitoring system (TPMS).

WARNING!

- In any of the aforementioned scenarios, avoid sharp turning and sudden braking, and contact a BYD authorised dealer or service provider.



LV Power Supply System Fault Warning Indicator

If on, it indicates that the DC-DC or the 12V battery (starter Fe battery) has failed and the vehicle speed is restricted. Contact a BYD authorised dealer or service provider.



Parking System Fault Warning Indicator

If on, it indicates that the brake fluid level is low or the brake system has failed.

When the brake system fails, this indicator is lit constantly along with a message "Please check the brake system" on the instrument cluster. Contact a BYD authorised dealer or service provider.



Seat Belt Reminder

If on, this indicator alerts you that the driver or a passenger belt is not fastened.



SRS Fault Warning Indicator

If on or flashing, it indicates that the Supplemental Restraint System (SRS) has failed. Contact a BYD authorised dealer or service provider.



Steering System Fault Warning Indicator

If on, the steering system has failed. Contact a BYD authorised dealer or service provider.



Battery Overheat Warning Indicator

If on, it indicates that the battery is too hot. Should this occur, stop the vehicle immediately to let it cool down. If it is still on after the vehicle has stopped and the battery has cooled down, contact a BYD authorised dealer or service provider.



Battery Fault Warning Indicator

If on, it indicates that the battery system has failed. Contact a BYD authorised dealer or service provider.



Motor Coolant Warning Indicator

If on, it indicates that the motor coolant is overheating. Stop the vehicle and let it cool down. If it is still on after the vehicle has stopped and the motor has cooled down, contact a BYD authorised dealer or service provider.

The flashing indicator means low coolant level. Refill the coolant immediately.



Power System Fault Warning Indicator

If on, it indicates that the power system has failed. Contact a BYD authorised dealer or service provider.



Motor Fault Warning Indicator

If on, it indicates that the motor system has failed. Contact a BYD authorised dealer or service provider.



Motor Overheating Warning Indicator

If on, it indicates that the motor is overheating. Stop the vehicle and let it cool down. If it is still on after the vehicle has stopped and the motor has cooled down, contact a BYD authorised dealer or service provider.

Pulling Out of Parking Spaces

Starting the Vehicle

Normal starting

1. Enter the vehicle carrying the remote control key.
2. Make sure that the parking brake has been applied, and the vehicle is in Park.
3. Press the brake pedal and "START/STOP" button. The  indicator lit up on the instrument cluster indicates that the vehicle has been started successfully.



WARNING!

- Do not press the "START/STOP" button while the vehicle is running in order to prevent any accidents due to power system shutdown.

Remote starting

You can also start up the vehicle using the remote control key.



When the remote control key is within the detectable signal range, press and hold the remote start button  outside the vehicle to start it.

Starting with the NFC Key Card*

1. Use the NFC key card to unlock the vehicle.
2. Press the brake pedal and press the "START/STOP" button. The  indicator lit up on the instrument cluster indicates that the vehicle has been started successfully.

REMINDER

- The vehicle can be started within 10 minutes after the NFC key card is used.

Emergency Starting

The vehicle allows emergency starting whenever the battery SOC of the remote control key is low. Refer to **Emergency - Owner's Emergency - Emergency Starting**.

Switching Driving/Terrain Modes

Different driving modes provide different driving experiences. Choose the desired driving mode.

ECO/SPORT Mode



Move the adjustment lever forward to enter ECO mode.

Move the adjustment lever backward to enter SPORT mode.

! REMINDER

- After the driving mode is set, the ECO/SPORT indicator will be on, and the background of both the instrument cluster and centre console touchscreen change at the same time.
- ECO mode provides better range than SPORT mode.

SNOW Mode

When driving on grass, snow, ice or gravel, the SNOW mode is recommended.



Press the SNOW mode button to enable/disable this mode.

When the SNOW mode is enabled, the background of the instrument cluster changes to the SNOW mode background, and the SNOW mode indicator  on the instrument cluster will be on.

Switching to Steering Assist

Tap on  /  > **Vehicle Settings** > **Driving Comfort Adjustment** > **Steering Assist** on the centre console touchscreen to select the Steering Assist modes.

- **Comfort:** Reduces the effort required to turn the wheel. The vehicle feels easier to drive and park.
- **Sport:** Increases the effort required to turn the wheel. When driving at higher speeds, the vehicle feels more responsive.

! REMINDER

- For improved driving comfort, it is recommended that the steering assist mode should be set before driving.
- When the vehicle is in the SNOW mode, steering assist mode cannot be adjusted. The steering assist mode prior to enabling SNOW mode is used by default.

Shifting Gears

Gears



"R": Reverse

This gear must be engaged only after the vehicle has come to a complete stop.

"N": Neutral

This gear can be engaged for temporary parking.

! WARNING!

- Make sure to engage the parking brake or press the brake pedal whenever the vehicle is temporarily parked in Neutral. Otherwise, the vehicle may move and cause an accident
- To prevent accidents, do not coast in neutral (N) gear.

"D": Drive

This gear is engaged for normal driving.

Gear Position Buttons



1 "UNLOCK" button

Press the "UNLOCK" button to exit Park or shift to Reverse.

2 "P" gear button

Press this button when the vehicle is stationary.

Shifting Gears

Shifting to Drive, Neutral and Reverse



Press the brake pedal, push the gear shift lever in the desired direction after the vehicle has come to a complete stop. After the gear shift lever is released, it automatically returns to the central position.

Shifting to Park

Press the brake pedal and the "P" gear button after the vehicle has come to a complete stop.

! REMINDER

- When the vehicle is powered on and in Drive or Reverse at a speed below or equal to 3 km/h, the vehicle shifts to Park automatically if the front left door is opened.
- If the vehicle speed is below or equal to 3 km/h, the vehicle can also be shifted to the desired gear as the gear shift lever is pushed in the corresponding direction.

Electronic Parking Brake (EPB)

To engage or release the parking brake, use the EPB switch.

! REMINDER

- The EPB system applies a constant force depending on a given slope to park the vehicle. If the vehicle begins to slide after parking on a slope, the EPB system automatically increases the braking force.

Engaging EPB



- **Manual application:** Press the brake pedal when the vehicle is stationary, and pull up the EPB switch. The EPB indicator (P) on the instrument cluster flashes and then goes steady.
- **Auto application:** After the vehicle has come to a complete stop, turning off power by pressing the "START/STOP" button or shifting to Park automatically engages EPB. The EPB indicator (P) on the instrument cluster flashes and then goes steady.

! WARNING!



- EPB must be engaged when parking.
- The flashing EPB indicator (P) indicates that EPB is functioning. Try not to release the brake pedal on a slope in order to prevent sliding. Do not release the brake pedal until the EPB indicator (P) goes steady.
- If the vehicle slides on a slope after EPB is engaged, press the brake pedal, park the vehicle on a flat road, and immediately contact a BYD authorised dealer or service provider.

! REMINDER

- Motor noise when engaging/releasing EPB is a normal occurrence.

Releasing EPB



- **Manual release:** When the vehicle is in any gear other than Park and EPB has been engaged, press the brake pedal and the EPB switch. The EPB indicator  goes out along with a text prompt reading "Parking brake released" on the instrument cluster.
- **Automatic release:** When the vehicle is parked on a slope below 10 degrees, press the brake pedal and shift from Park or Neutral to Drive or Reverse to automatically release EPB. The EPB indicator  goes out along with a text prompt reading "Parking brake released" on the instrument cluster.

Automatic Vehicle Hold (AVH)

The AVH system can automatically ensure the vehicle remains stationary. When the vehicle is stopped while the power system is running, especially when waiting for traffic lights or driving on busy roads, using AVH can make it so the driver does not have to continuously press the brake pedal or engage the parking brake via the EPB switch.

Conditions to Enable AVH

The AVH system can be enabled if:

- The driver has fastened the seat belt,

and all doors are closed;

- The vehicle is powered on.

Turning AVH On/Off



After the conditions above are all met, press the AVH button to turn AVH on. The switch indicator then lights up. At this time, the AVH function is in standby, and the AVH indicator on the instrument cluster lights up (white).

Press the AVH button again to turn it off.

After the vehicle has come to a complete stop by pressing the brake pedal, the AVH function has been enabled along with both the brake lights and the high mount brake light on, and the green AVH indicator  is displayed on the instrument cluster. The brake pedal can then be released.

After 10 minutes of operation, AVH reverts to standby and EPB engages automatically.

To release and revert the AVH function back to standby, press the accelerator pedal and shift to Park or pull up the EPB switch.

Driving at Low Speeds

With AVH in standby:

- When shifting to Park, the AVH function takes effect if the vehicle is moving at a low speed. When backing up the vehicle in Reverse at a low speed or driving in Drive at a low speed, the AVH function is restrained to facilitate the smooth

movement of the vehicle at low speeds.

- Once the vehicle is moving at a low speed, pressing the AVH button or increasing the vehicle speed to more than 10 km/h will deactivate the AVH function.

! WARNING!

- When the AVH function is enabled (green indicator) and the vehicle cannot be parked due to a serious EPB fault, the instrument cluster will display "Please check the ESP system". The driver has to take over the vehicle as the AVH function maintains pressure for 2 seconds, after which it will release pressure.

! WARNING!

- Do not place any objects in the driver's footwell in order to prevent accidents caused by pedal obstruction.
- Before driving, confirm that all pedals can be pressed all the way down, and that they spring back without any impediment.
- The driver must wear vehicle-friendly shoes that enable them to feel the pedals.

! CAUTION!

- Frequent pressing of the brake pedal for extended periods can cause brake overheating and temporary loss of braking performance. It may also result in excessive abrasion of brake pads and increased braking distance.

Vehicle Speed Control

Brake/Accelerator Pedal

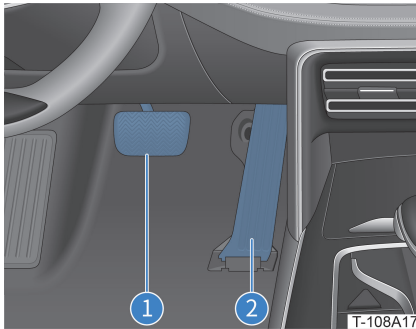

- 1 Brake pedal
- 2 Accelerator pedal

Light Control

Exterior Lights

Light Operation

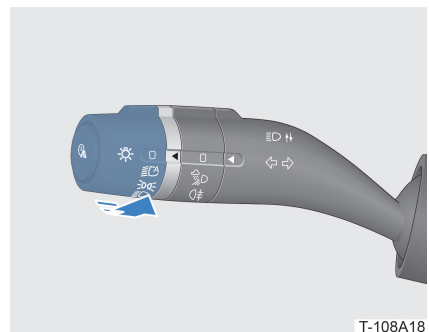

 OFF Position

Rotate the end knob of the light stalk switch to this position to turn off all lights (except for daytime running lights).

Auto Light Position

When the end knob of the light stalk switch is in this position, the clearance lights and low beam will turn on or off automatically according to the lighting conditions.

REMINDER

- The light sensor is located at the upper end of the front windscreen. If it is obstructed, the clearance lights and the low beam may not turn on or off automatically as dictated by the auto light position.

Clearance Light Position

Rotate the end knob of the light stalk switch to this position to turn on the clearance lights, front side light, rear side light, rear license plate light, some backlights, etc.

Low Beam Position

Turn the end knob of the light stalk switch to this mode to turn on the low beam and clearance lights.

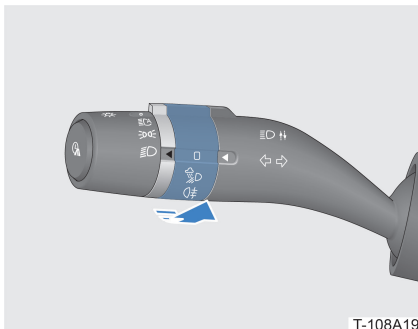

All-weather Lights

Rotate the fog light knob to the  position to turn off the all-weather lights by default.

This function is not active.

Rear Fog Light Position

Turn on the low beam, then rotate the fog light knob to the  position to turn on the rear fog lights.

Left and Right Turning lights

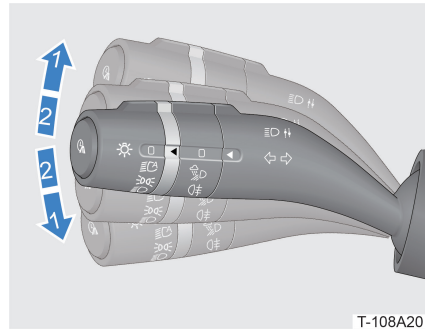

Turning light: Moving the light stalk switch to position "1" and releasing will make the turning light on the corresponding side flash continuously, with the light stalk switch not returning automatically. After the steering wheel returns, the light stalk switch will return automatically.

Lane change signal: Moving the light stalk switch to position "2" and releasing will make the turning light on the corresponding side flash 3 times, with the light stalk switch returning automatically.

High Beam

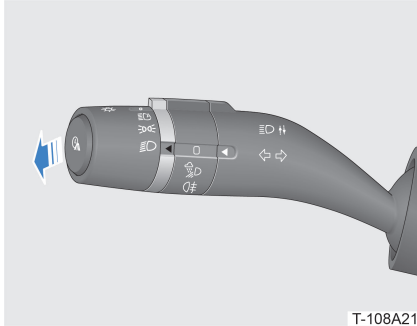

Turn on the low beam, and push the light stalk switch away from the steering wheel to turn on the high beam.

Flashing High Beams

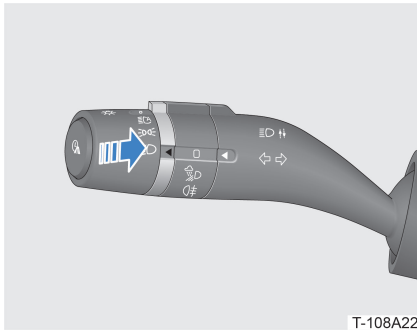

Pull the light stalk switch towards the steering wheel to send an overtaking signal. Release the switch to let it automatically return to its original position. To indicate overtaking intention, pull it repeatedly to flash the high beam.

Corner Lights

With low beam lights on, turn the steering wheel and turn on the turning light, or shift into Reverse to turn on the corner lights.

Daytime Running Lights

When the vehicle is powered on with the low beam off, the daytime running lights turn on automatically.

When the low beam is on or the vehicle switches from on to off, the daytime running lights turn off automatically.

Auto Off

The auto off function can be enabled if:



1. The clearance lights or low beam are on;
2. The vehicle switches from on to off.

With this function activated:

- When the front left door is closed, any lights that are lit will turn off automatically after 10 seconds.
- When the front left door is opened, any lights that are lit will turn off automatically after 10 minutes.

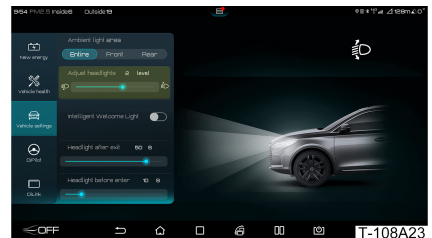
Headlight Height Adjustment



When the low beam is on, tap on  /  > **Vehicle Settings > Lights & Ambient** on the centre console touchscreen to adjust the vertical beam angle of the headlights.

Vehicle Loading Conditions	Recommended Levels
One person in the driver seat	
The driver, plus one passenger in the front seat	0~2
The driver, one passenger in the front seat, all the seats farthest to the rear occupied	
All the seats occupied	0~3
All the seats occupied, plus an evenly distributed load (calculated based on the technically permissible maximum laden) in the luggage boot	0~2.5
Driver, plus an evenly distributed load (calculated based on the technically permissible maximum laden) in the luggage boot	0.5~3

The advised adjustments may differ in other vehicle loading conditions. Intermediate adjustments can be chosen.

High Beam Assist (HMA)

The HMA system uses a multi-function video controller on the front windscreen to determine current driving conditions and, if necessary, automatically switches between high/low beams.

Turning on HMA



Tap on / > **DiPilot** or pull down **Quick Settings** menu on the centre console touchscreen to turn on **Smart Headlights**.

Activating HMA

Rotate the end knob of the light stalk switch to the position. When the vehicle speed is above 35 km/h and necessary lighting conditions are met, HMA activates automatically. It also allows automatic switch between high beam and low beam according to the current driving conditions.

REMINDER

- When HMA is activated, the HMA indicator on the instrument cluster is on.

Turning off HMA

The HMA can be turned off by:

- Rotating the end knob of the light stalk switch away from the position;
- Tapping on / > **DiPilot** or pulling down **Quick Settings** menu on the centre console touchscreen to turn off **Smart Headlights**;
- Turning high beam on manually.

HMA Restrain Conditions

HMA will be restrained if:

- The vehicle speed remains under 35 km/h;
- Fog lights/turning lights are turned on or the vehicle is turning in an emergency.

System Limit

HMA may be accidentally triggered or may not be triggered in some conditions. Should these occur, the driver has to control the lights as necessary.

- The vehicle is running on a road where there are poorly lit up traffic participants (e.g. Pedestrians, bicycles, etc.), railways or waterways nearby, or wild animals.
- The front windscreen is covered with fog or dirt or blocked by labels or ornaments.
- The vehicle is running in an environment where there is strong reflection (e.g. expressway traffic signs, puddles on the road surface, etc.).

CAUTION!

- In the event of a collision or re-installation of the sensors, contact a BYD authorised dealer or service provider to calibrate.

Wipers Control

Front Wipers Control

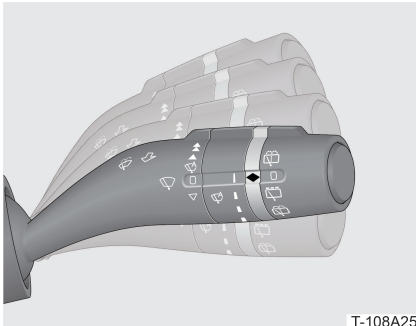

Move the wiper switch forward/backward to the corresponding position. The wiper motions will be as follows:





In this position, the front wipers move fast at a set frequency.

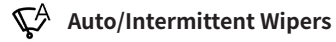

In this position, the front wipers move slowly at a set frequency.



Tap on  /  > **Vehicle Settings > Driving Comfort Adjustment** on the centre console touchscreen to enable **Auto Wiper**.

When in this position, wipers work automatically according to rain detection if the Auto Wipers function is enabled.

When in this position, the wipers enter intermittent mode if the Auto Wipers function is disabled.

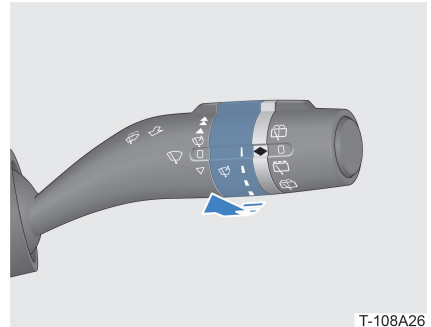

In auto wiper mode: rotate the adjustment switch to adjust the automatic wiping frequency.

In intermittent mode: rotate the adjustment switch to adjust the intermittent frequency.

OFF position

In this position, the front wipers are off.

MIST position

When moving the switch to this position and holding, the front wipers will move slowly at a set frequency. Release the lever to stop the wipers.

Moving the switch to this position and releasing it will make the front wipers stop after wiping once.

Washer Jets

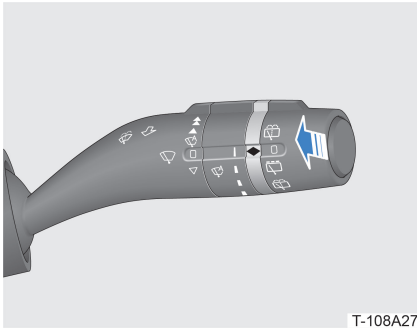

Pull up the wiper switch and hold. The front windscreen washer jets will spray water along with wiping motions. Release the switch to make the washer jets stop spraying, followed by 3 times of wiping motions. Another wiping motion follows a few seconds later.

Rear Wiper Control

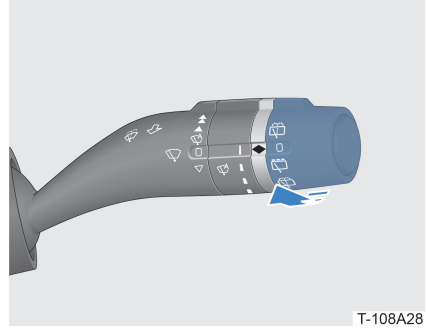

Rotate the end knob of the wiper switch forward/backward to the corresponding position. The wiper motions will be:

MIST Position

Rotate the end knob of the wiper switch to this position and release. The knob will return to its original position and the rear windscreen washer jets will spray water once along with 4 times of wiping motions.

OFF Position

In this position, the rear wiper is off.

WIPER Position

In this position, the rear wiper will work at a set frequency with the washer jets inactive.

Washer Jet Position

In this position, both the wiper and the washer jets are active.

! REMINDER

- Before using the wipers, remove any ice or snow on the windscreen, and make sure that the wiper blades are not frozen and stuck to the windscreen.
- Check and maintain the wiper blades regularly. Failure to do so will shorten their service life.
- In order to prevent damage to the windscreen and wiper blades, do not use the wipers on a dry windscreen or when there is no washer fluid in the tank.

Driving Assist

Intelligent Cruise Control (ICC)*

Intelligent cruise control (ICC) is a system combining adaptive cruise control (ACC) with lane keeping system (LKS). ICC provides drivers with longitudinal and lateral vehicle control assistance within speeds from 0 to 150km/h. It relieves the driver of duty and creates a safe, comfortable driving environment.

Turning ICC On

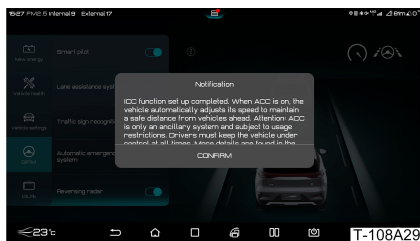

Tap on  /  > **DiPilot** or pull down **Quick Settings** menu on the centre console touchscreen to turn **Smart Pilot** on along with a prompt popping up on the screen.

! REMINDER

- The ICC system memorises the on/off status of this function in the previous driving cycle by default.

With ICC on, ACC activated, and vehicle speed between 0-60 km/h:

- When there are identifiable lane markings on the left and right sides of the vehicle:
 - » The vehicle will run in the centre of the lane, regardless of whether there is a target vehicle ahead or not.
- When the vehicle moves from a road with clear lane markings to a road with unclear lane markings or without lane markings:
 - » The vehicle will follow the vehicle ahead and make minor lateral movements if there is a target vehicle ahead.
 - » If there is no target vehicle ahead, ICC will be restrained, with only ACC remaining active.

With ICC on, ACC activated, and vehicle speed between 60-150 km/h:

- When there are identifiable lane markings on the left and right sides of the vehicle:
 - » The vehicle will run in the centre of the lane, regardless of whether there is a target vehicle ahead or not.
- When the vehicle moves from a road with clear lane markings to a road with unclear lane markings or without lane markings:
 - » ICC will be restrained with only ACC remaining active, regardless of whether there is a target vehicle ahead or not.

! WARNING!



- ICC serves as a driving assist system rather than an autonomous driving system. Drivers must therefore always keep the vehicle under control and never remove their hands from the steering wheel for extended periods. Doing so may force the driver to take over and ICC to be disabled.
- ICC system performance may be compromised due to weather, lighting, visibility of lane markings, etc.
- Precautions must be taken when using ACC and LKS.

Adaptive Cruise Control (ACC)

Based on conventional cruise control, adaptive cruise control (ACC) is designed to actively control the vehicle speed. This is done via radar sensors which detect the vehicle's distance and speed relative to the vehicle ahead for auto follow-up while cruising. ACC can automatically switch between fixed speed cruise and follow-up cruise depending on whether there is a vehicle ahead.

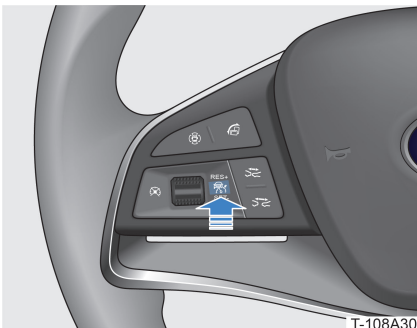
Turning ACC On



Press the ACC button  on the steering wheel to turn ACC on. When the function is enabled, ACC indicator  (white) on the instrument cluster will light up.

Activating ACC

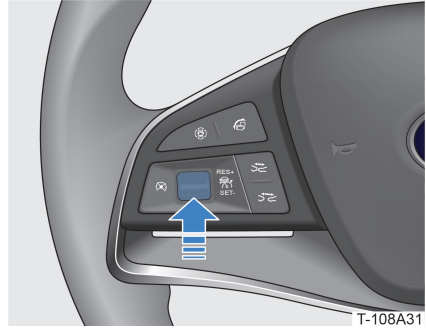

With ACC turned on:

- If a cruise speed has been set, push the left lever on the steering wheel up to resume the speed that was previously set the last time exiting ACC.
- If no cruise speed has been set, pull the left lever on the steering wheel down to set the current speed as the cruise speed. Cruise speed can be set between 30-150 km/h. If the current speed is not within this range, ACC will automatically set the cruise speed to either 30 km/h or 150 km/h depending on the current speed.

After ACC is activated, the vehicle will move at the fixed cruise speed and automatically control the distance from the target vehicle ahead.

ACC can be activated if:

- EPB is released;
- The vehicle is in Drive;
- All doors are closed;
- The driver seat belt is fastened;
- ESC is turned on but not activated;

- The brake pedal is pressed down when the vehicle speed is 0 km/h; the brake pedal is not pressed down when the vehicle speed is between 0 km/h and 150km/h;
- No vehicle network communication fault prompt is displayed on the instrument cluster;
- AEB is not activated.

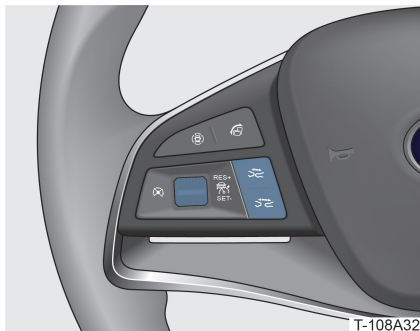

Setting Cruise Speed and Time Interval



When the ACC is activated, follow the procedure below to adjust the cruise speed and the following distance:

Adjusting cruise speed: push up the left lever on the steering wheel to increase the speed by 5 km/h. Pull it down to decrease the speed by 5 km/h.

When in standby, ACC memorises the last cruise speed set for the same driving cycle.

Adjusting following distance: ACC automatically adjusts the following distance according to the current cruise speed. The following distance can also be decreased by pressing the  button or increased by pressing the  button on the steering wheel.

There are 4 following distance levels. At each level, the following distance is in direct proportion to the vehicle speed; the higher the vehicle speed, the greater the following distance.

Active Acceleration/Deceleration While ACC Is Activated

When ACC is activated, press the accelerator pedal to increase the vehicle speed. If it is necessary to set a new cruise speed, pull down the left lever on the steering wheel to set the current speed as the new cruise speed. If no further action is taken, the vehicle will resume the previous cruise speed after the accelerator pedal is released.

When the vehicle speed is above 150 km/h or when the accelerator pedal is pressed down continuously for more than 15 minutes, ACC will automatically disable. The driver has to re-activate it.

If the brake pedal is pressed when ACC is activated, the vehicle will decelerate, and ACC will automatically disable. ACC has to be re-activated after the brake pedal is released.

Follow-to-Stop/Start

With ACC, the vehicle can follow the vehicle ahead to stop while in normal driving conditions.

- If the stop time is within 3 seconds, the vehicle can follow the vehicle ahead to start automatically.
- If the stop time is between 3 seconds and 3 minutes, ACC must be re-activated by either pressing the accelerator pedal or pressing the ACC button .
- If the stop time is more than 3 minutes, ACC automatically disables, and EPB applies automatically.

Deactivating ACC

Deactivating ACC means it is disengaged to enter standby from the active state.

ACC is deactivated if:

- The brake pedal is pressed;

- The ACC deactivation button  on the steering wheel is pressed;
- The vehicle speeds up to more than 150 km/h.

Turning ACC Off

To completely turn ACC off, press the ACC button  when ACC is on.

WARNING!

- ACC is a system strictly meant to enhance comfort, rather than a safety system, nor an obstacle detector or collision warning system.
- ACC is meant to assist the driver, not replace them. The driver must maintain control of the vehicle at all times according to traffic rules and must also be fully responsible for the vehicle.
- The driver must adjust the distance with any vehicles ahead and reasonably set ACC depending on the traffic flow ahead as well as current weather conditions (e.g. rain, fog, etc.). After ACC is reasonably set, the driver must make sure that the vehicle can be decelerated to a stop at any time.
- ACC is suitable for use on expressways and roads in good conditions, but not for use on complex urban roads or mountain roads.
- If the driver presses the accelerator pedal or brake pedal while ACC is running, the vehicle will be taken over by the driver. However, the distance control function of ACC will not be activated.
- ACC cannot be activated if ESC is not on.

WARNING!

- ACC responds only in special circumstances to stationary or slow moving objects (e.g. bicycles or pedestrians, etc.).
- ACC cannot recognise pedestrians and oncoming vehicles.
- ACC allows limited braking only and cannot carry out emergency braking.
- If a vehicle ahead brakes suddenly (emergency stop), ACC may fail to react or be slow in reacting, resulting in late braking. In this event, the driver will not receive a take-over request.
- When the vehicle goes into or out of a curve, target selection may be delayed or disturbed. In this event, the vehicle may not brake as expected or brake too late.
- In some cases (for example when a vehicle ahead is running slowly relative to the vehicle, changing lanes too suddenly, or keeping an excessively short safety distance), ACC will not have enough time to reduce the relative speed. In such events, the driver must react appropriately. ACC cannot provide an audio or visual alarm under such circumstances.
- On sharp curves (e.g. winding roads), due to limitations in the view of the vehicle sensors, information of a vehicle ahead may be lost for a few seconds, causing the vehicle to accelerate with ACC.
- If the vehicle runs too close to an adjacent lane or another vehicle on an adjacent lane runs too close to the lane on which the vehicle is running, ACC may apply braking in response to the corresponding vehicle.

WARNING!

- If another vehicle changes to the lane on which the vehicle is running and falls within the detection range of the radar, it will be recognised as a target vehicle and a response will be received. In this event, forced braking or late braking may occur.
- While following a vehicle ahead to stop, ACC is unable to identify the end of the target vehicle ahead and will instead identify its lower end (e.g. the rear axle of a truck with high chassis or the bumper of a vehicle) in very few cases. Should these occur, ACC is unable to ensure a proper stopping distance, and the driver must stay vigilant and ready to brake at any time.
- When ACC is activated while the vehicle is stationary, it will identify any stationary obstacle in front as a vehicle. It will then keep the vehicle stationary to ensure safe starting so as to avoid collision with said stationary target caused by unexpected starting. However, this function cannot identify all obstacles, so the driver must ensure that there are no obstacles or other traffic participants in front of the vehicle.
- Radar sensors can be affected by vibration or collisions, resulting in compromised ACC performance. Should this occur, contact a BYD authorised dealer or service provider.

WARNING!

- Radar sensors are installed in the front area of the vehicle. Pollutants blocking the visual field will interfere with expected functions. ACC will be deactivated when snow accumulates and completely covers the sensor. If it has been deactivated, ACC will notify the driver through the instrument cluster. At this time, remove the pollutants and restart the vehicle, or drive along a normal road for a certain distance to return system functions to normal.
- If the vehicle runs under special road conditions such as a circular parking lot or a tunnel for an extended period, the radar may malfunction for a short time due to limitations in its detection capabilities. In this event, the driver can restore function by restarting the vehicle or by driving along a normal road for a certain distance.
- Structural retrofitting of the vehicle (such as lowering the chassis or changing the front license plate frame) may compromise ACC performance.
- Metal objects such as rails or metal plates may interfere with the radar and make it unable to be fully functional.
- In some circumstances, detection may be affected or delayed. If the radar reflection cross-sectional area of the target is too small (e.g. a bicycle, carriage, or pedestrian), there is a risk that ACC will be unable to identify the distance from the target ahead, resulting in late response or no response to these targets. Moreover, the detection may be affected by noise or electromagnetic interference, resulting in delay or interference. Should these situations occur, the driver needs to control the vehicle speed.

! WARNING!

- When the overlap between the vehicle and the vehicle ahead is too small, ACC will be unable to identify the vehicle ahead as the target. In this event, the driver needs to maintain control of the vehicle.
- Do not use the ACC system when driving on roads with poor visibility, ramps, multiple curves or roads that are slippery (such as snowy, icy, wet or waterlogged sections).

! CAUTION!

- Contact a BYD authorised dealer or service provider to calibrate the radar sensors if:
 - » Radar sensors have been removed;
 - » Four wheels have been re-aligned due to wheel deviation;
 - » A collision happens;
 - » The ACC system performance degrades or the instrument cluster indicates system abnormality.

Lane Keeping System (LKS)*

LKS detects lane markings ahead through the multi-function video controller on the front windscreen. When the vehicle speed is above 60 km/h, LKS keeps the vehicle running in the lane by controlling the steering system, thus relieving the driver of some duty and improving comfort and driving experience.

Turning LKS On



Press the LKS button  to turn LKS on. A prompt reading "Lane assist setting is successful, the function will be on if the speed exceeds 60km/h" will be displayed on the instrument cluster.

! REMINDER

- LKS memorises the on/off status of this function in the previous driving cycle by default.

Activating LKS

When LKS detects the lane line, it will control the steering system to keep the vehicle within the current lane.

Deactivating LKS

LKS can be deactivated by:

- Turning the steering wheel, turning on the turning lights or hazard warning indicator;
- Sharply accelerating, decelerating the vehicle or turning the steering wheel quickly while driving;
- If LKS detects that the driver has not held the steering wheel for 15 seconds while it is active, a hands-off warning will be given, and the instrument cluster will prompt "LKS is off, hold steering

wheel". At this time, if the driver's hands remain off the steering wheel, LKS will disengage.

Turning LKS Off

With LKS turned on, press the LKS button  to turn it off.

WARNING!

- LKS is not meant for autonomous driving. It is designed to assist the drivers instead of replacing them. Improper use or negligence may cause traffic accidents and even serious personal injury. Therefore, the driver still needs to keep eyes on the road and traffic conditions. Always hold the steering wheel with both hands, be ready to take over the vehicle at any time, keep the vehicle within the correct lane, and maintain awareness in order to prevent accidents. The driver must always take responsibility for driving safety.
- LKS is only applicable for use on paved roads that are in good conditions and are well marked.
- Pay attention to relevant information shown on the instrument cluster screen and operate the vehicle as required.
- Vehicle speed must be adjusted depending on the visibility, weather conditions, road and traffic conditions, and a proper distance from the vehicle ahead must be kept.
- In the event that LKS is caused to disengage unexpectedly due to sharp curves, slopes, unclear lane markings, or excessively wide or narrow lanes, the lane markings changing on the instrument cluster will be the only prompt to inform the driver of the disengaged LKS.

WARNING!

- LKS cannot always properly recognise lane markings, and may sometimes mistake inferior road surfaces, some road structures, or other objects for lane markings. Should this occur, it should be turned off immediately.
- If the section of the front windscreen where the multi-function video controller is located is dirty, a text prompt will pop up on the instrument cluster reading "Smart cameras not applicable due to environment limitations". If this section is damaged, LKS functionality can be severely affected.
- Excessive tyre wear or excessively low tyre pressure can worsen LKS performance.
- When the vehicle deviates from the lane in a curve, a special prompt for deactivated LKS may not be given. Drive carefully.
- When there is a rough transition on the lane markings, the steering wheel may be caused to turn considerably. Drive carefully.
- When the lane markings are close to the kerb, the multi-function video controller may move back and forth to identify the lane markings and the kerb, resulting in the steering wheel turning back and forth. Drive carefully.
- LKS may incorrectly recognise or fail to recognise lane markings on a rainy or snowy day, or on a muddy road surface, which will affect vehicle driving safety. Activating LKS is not recommended in such cases.

Lane Departure Warning System (LDWS)

LDWS detects front lane markings by using a multi-functional video controller. When the vehicle speed is above 60 km/h and the driver unconsciously drifts out of the lane, LDWS will alert the driver.

Turning LDWS On



Pull down **Quick Settings** menu and tap on / > **DiPilot** > **Lane Assistance System (LAS)** on the centre console touchscreen to turn **LDWS** on. A prompt reading "Lane assist setting is successful, the function will be on if the speed exceeds 60km/h" will be displayed on the instrument cluster.

REMEMINDER

- LDWS memorises the on/off status of this function in the previous driving cycle by default.

Setting LDWS



Tap on / > **DiPilot** > **Lane Assistance System (LAS)** on the centre console

touchscreen to set the LDWS warning modes:

Reminder mode: Voice, Vibration, Both.

LDWS Working Status

Lane markings are displayed on the instrument cluster when LDWS is turned on.

Colour	Descriptions
Grey	Lane markings are unidentified.
Green	Lane markings have been identified.
Red	The vehicle has deviated while the driver is not actively changing lanes. At this time, the vehicle will emit an alarm as set, prompting the driver to quickly correct orientation.

Turning LDWS Off

Pull down **Quick Settings** menu and tap on / > **DiPilot** > **Lane Assistance System (LAS)** on the centre console touchscreen to turn it off.

System Limit

LDWS may incorrectly detect or fail to detect lane markings in complex traffic road environments, and may not function or be significantly worsened if:

- Line of sight is poor due to snow, rain, fog, etc.;
- The front windscreen is dirty and foggy or there is an object in front of the multi-function video controller;
- Glare is caused by direct sunlight, reflections from accumulated water on the road surface, incoming vehicles on

the opposite lane, etc.;

- There are sudden changes in ambient brightness, for example when entering/exiting tunnels;
- Lane markings shadowed by isolation strips are unidentifiable;
- The threshold between road and side grass, soil or kerb, etc. is unidentifiable.

! WARNING!

- If the driver turns the turning light on and changes lanes, LDWS will be restrained.
- LDWS may be restrained if the driver drives on the lane markings or if the lane markings are unidentifiable, too thin, worn, blurred or covered by dirt/snow.
- LDWS may be restrained if the lane is too wide or narrow, the number of lanes increases or decreases, the lane markings change temporarily (such as ramps or expressway exits) or the layout of the lane markings is complex.
- LDWS may be restrained if the vehicle is running on a steep slope or curved road, the distance from the vehicle ahead is too close or the vehicle ahead blocks the lane markings.
- LDWS may be restrained if the vehicle is running over large bumps, is accelerating or decelerating sharply, or if the driver is turning the steering wheel too quickly.
- Elements that may affect the view of the multi-function video controller and normal operation of the system include: cracked or coloured windscreen, additional coatings that go against the rules, light-reflective items placed on the dashboard, etc.

! WARNING!

- The visual field of the multi-function video controller must not be blocked by objects or suffer from strong light interference. Otherwise, LDWS will disengage. LDWS can automatically resume when the field of vision returns to normal. If it fails to resume on its own, contact a BYD authorised dealer or service provider.

! REMINDER





- It is recommended to turn LDWS off when driving:
 - » In an aggressive manner;
 - » In harsh weather;
 - » Through poor road sections.

Blind Spot Detection (BSD)

BSD covers blind spot monitoring, side assist, rear crossing traffic alert, rear collision warning, and door opening warning. It uses radar sensors to determine current traffic conditions, and prompts the driver to pay attention to driving safety when needed.

Turning BSD On



Press the BSD button  or pull down **Quick Settings** menu or tap on  /  > **DiPilot** on the centre console touchscreen to turn **Blind Spot Detection** on. When the function is enabled, the BSD indicator  on the instrument cluster will light up.

REMINDER

- BSD memorises the on/off status of this function in the previous driving cycle by default.

Blind Spot Detection (BSD)

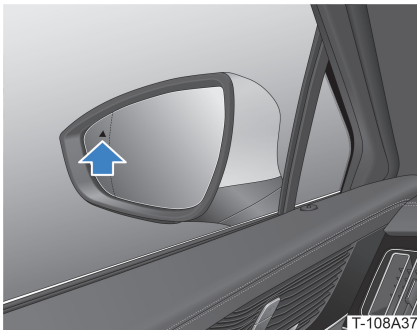

When the radar sensors detect that there is a vehicle in the blind spot of a side mirror when the vehicle is moving at a speed above 30 km/h, the alarm indicator on the corresponding side mirror will light up. If the turning light on the same side is turned on at this time, the warning indicator on the corresponding side mirror will flash, alerting the driver of possible danger if they insist on changing lanes.

Side Assist

When the radar sensors detect that there is a vehicle quickly approaching from the adjacent lane while the vehicle is moving at a speed of above 30 km/h, the alarm indicator on the corresponding side mirror will light up. If the turning light on the same side is turned on at this time, the warning indicator on the corresponding side mirror will flash, alerting the driver of possible

danger if they insist on changing lanes.

Rear Crossing Traffic Alert (RCTA)

RCTA uses radar sensors to detect moving vehicles on the left and right sides when the vehicle is reversing, alerting the driver of a risk of collision.

If RCTA determines that a collision is about to take place with vehicles approaching from the left and right side while reversing, the warning indicator on the corresponding side mirror will flash to alert the driver of possible danger should they continue reversing and remind them to drive carefully.

Rear Collision Warning (RCW)

When the radar sensors detect that a vehicle is approaching quickly from behind and there is a risk of collision while the vehicle runs at a speed above 5 km/h, the turn signal on the instrument cluster and the alarm lights on both side mirrors will light up and flash to remind the driver to drive carefully.

Door Opening Warning (DOW)

When the door is about to be opened while the vehicle is in Park, DOW uses the rear radar sensors to identify short-range targets behind and to the side of the vehicle, and will issue an alarm through the DOW indicator on the side mirrors to prevent possible accidents.

Turning BSD Off

With BSD on, press the BSD button  or pull down **Quick Settings** menu or tap on  /  > **DiPilot** on the centre console touchscreen to turn it off.

System Limitations

In some cases, BSD may be affected or delayed. Possible scenarios include but are not limited to:

- Vehicles approaching from behind change lanes at the last moment;
- Detection of vehicles approaching from behind is delayed in sharp curves, ramps or other situations;
- A vehicle behind is running at a speed exceeding 80 km/h relative to the vehicle;
- The target vehicle is blocked;
- The radar reflection cross-sectional area of the target vehicle is too small (e.g. bicycles, E-bikes, etc.);
- The turning radius is too small, or the vehicle is running in/out of a curve;
- Harsh weather e.g. rain, snow, etc.

! WARNING!

- BSD can assist the driver in monitoring the blind spots on the left and right side mirrors, but it does not serve as a substitute for the driver's subjective observation and judgment while driving. The driver must drive properly by maintaining control of the vehicle at all times, and be fully responsible for vehicle safety.
- If a target vehicle is fast approaching from behind, BSD may not provide a warning in time.
- The driver must make sure that BSD is operating normally and keep its position to install radar sensors in good condition. Any areas covered in mud, snow, or other obstructions should be cleaned as quickly as possible.

! WARNING!

- If irrelevant targets at the rear sides or behind the vehicle (e.g. large roadside repair signs, large roadside billboards, reflectors in tunnels, and other objects with large reflection cross-sectional areas) are detected as target vehicles by mistake, BSD will give a warning.
- The radar sensors may be affected by vibration or collisions, resulting in compromised BSD performance. Should this occur, contact a BYD authorised dealer or service provider.

Traffic Sign Recognition (TSR)*

TSR can automatically recognise speed limit signs on the road. If any signs are recognised, the TSR indicator  on the instrument cluster will light up to remind the driver to control their speed.

Turning TSR On

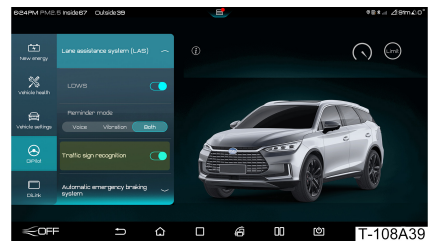

Pull down **Quick Settings** menu and tap on  > **DiPilot** on the centre console touchscreen to turn **Traffic Sign Recognition** on.

! REMINDER

- TSR memorises the on/off status of this function in the previous driving cycle by default.

Activating TSR

When the system recognises a speed limit sign for the current road after TSR is turned on, the sign will be displayed on the instrument cluster in the form of an indicator (e.g. ). If the current vehicle speed exceeds the speed limit by more than 5 km/h, the indicator light will flash reminding the driver to decelerate to a proper speed as soon as possible.

Turning TSR Off

Pull down **Quick Settings** menu and tap on  /  > **DiPilot** on the centre console touchscreen to turn it off.

WARNING!

- Whenever a sign has been recognised by TSR, the TSR indicator will go out after the vehicle has travelled for a certain distance. Therefore, the driver must keep the vehicle speed within a reasonable range.
- TSR is only used to remind drivers of traffic signs, and is not meant as a substitute for drivers' judgment regarding road speed limit information. The driver must be fully responsible for the safety of the vehicle under any and all circumstances.

CAUTION!

- TSR can be fully functional only when speed limit signs are clearly visible. Speed limit signs may either be unrecognisable or misrecognised if they:
 - » do not meet regulations;
 - » are decoloured, reflective, or unclear;
 - » are located on a curve;

CAUTION!

- » are erected at an improper angle;
- » are fully or partially blocked;
- » are too far away from the vehicle or erected too high;
- » are attached to the road surface.
- » Poor visibility (e.g. rain, snow, dust, haze, nighttime conditions).
- » Camera lenses light up by strong light or light intensity changes suddenly.
- » The front windscreen section around the camera lenses is polluted, damaged or blocked.
- » The vehicle is running too close to a vehicle ahead, blocking the detection of the camera.
- » The vehicle is running too slow.

Predictive Emergency Braking System (PEBS)

PEBS includes predictive collision warning (PCW) and automatic emergency braking (AEB). When PEBS detects a risk of collision with vehicles, pedestrians or other objects ahead, it will give an audio and visual alarm reminding the driver to take avoidance measures. PEBS will also apply braking in case of an emergency, and even potentially apply AEB in the event of a severe emergency, to assist the driver in avoiding a collision or reducing any injury.

Predictive Collision Warning (PCW)



Tap on / > **DiPilot > Automatic Emergency Braking System** on the centre console touchscreen to turn **Automatic Emergency Collision Warning** on/off.

With PCW on:

- **Safety distance alarm:** when the vehicle running at a speed of above 65 km/h is too close to another vehicle ahead for an extended period, PCW will issue a safety distance alarm along with the AEB indicator lit up on the instrument cluster to alert the driver of the insufficient following distance.
- **Pre-alarm:** When the driving speed is 30-150 km/h and PCW determines that there is a risk of collision with the vehicle ahead, an audio and visual pre-alarm will be given. The AEB indicator on the instrument cluster will light up and the buzzer will beep. The driver must take prompt and appropriate actions to ensure a safe following distance.
- **Emergency alarm:** When the driving speed is 30-150 km/h and the driver fails to take proper actions as soon as the pre-alarm is given, the risk of collision will be aggravated. The system will issue a visual and tactile pre-alarm, along with the AEB indicator flashing on the instrument cluster, possibly accompanied by short beeps to alert the driver to apply brakes. The driver must take prompt and appropriate actions to ensure a safe following distance.

AEB



Tap on / > **DiPilot > Automatic Emergency Braking System** on the centre console touchscreen to turn **Automatic Emergency Braking (AEB)** on/off.

If the driver does not respond to the emergency alarm and the situation escalates further, the system will enter AEB mode. The system will apply braking forces within its capability to avoid or mitigate any impact caused by the collision.

If the driver has applied brakes during an emergency but the braking forces are insufficient, the brake system will provide the maximum braking forces to avoid or mitigate any impact caused by the collision.

System Limit

PEBS may be affected or fail to work if:

- The vehicle is running in conditions with rain, snow, fog, excessive splashing or glare, where the system is exposed to direct sunlight, or where the lighting conditions vary greatly;
- The sensors are dirty, fogged, damaged or blocked;
- The radar malfunctions due to interference from other radar sources (e.g. strong radar reflections in multi-story parking lots).

In complex traffic situations, PEBS may not be able to respond correctly if:

- Pedestrians or vehicles are moving into the radar detection range too quickly;

- Pedestrians are blocked by other objects;
- The profile of pedestrians cannot be distinguished from the background;
- Pedestrians (e.g. wearing special clothing or being blocked by objects) cannot be detected;
- The vehicle is running on a curve with a small radius.

WARNING!

- PEBS does not guarantee collision avoidance under any circumstance, and cannot always clearly identify vehicles and pedestrians under complex traffic conditions. PEBS may trigger unnecessary alarms or braking due to ground manhole covers, iron plates or road signs.
- Be sure to drive safely and keep eyes on the surrounding traffic conditions. Under no circumstances shall AEB be used as a substitute for normal braking operation.
- AEB can only be activated when the driving speed is above 4 km/h. It cannot ensure that AEB will be triggered accurately under any working conditions. Please drive carefully.
- AEB will not be fully functional if ESC is turned off or the ESC fault indicator is on.
- Do not rely excessively on PEBS, as doing so may cause accidents and even serious personal injury. PEBS is only a tool to assist the driver; it is the driver's responsibility to maintain a proper distance from the vehicle ahead and control vehicle speed. The driver should be vigilant about braking and steering whenever necessary. The driver must always maintain control of the vehicle and bear full responsibility for safe driving.

WARNING!

- Whenever PCW issues a warning, the driver must apply the brakes based on current traffic conditions to decelerate or turn the steering wheel to avoid obstacles.
- A warning will be given if the vehicle ahead has been closely followed for an extended period. If the vehicle ahead brakes suddenly, a collision cannot be avoided.
- In the event of an emergency alarm, if the driver has taken corresponding measures (e.g. turning the steering wheel, and pressing the accelerator pedal or brake pedal), PCW will not continue to trigger AEB.

CAUTION!

- If the vehicle is running under special road conditions such as in a circular parking lot or a tunnel for an extended period, the radar sensors may experience temporary detection malfunctions. Should this occur, the driver can restore the function by restarting the vehicle or driving along a normal road for a certain distance.
- When the surface of the radar sensors or multi-function video controller is dirty or covered by foreign objects, the instrument cluster screen will display a corresponding prompt ("Dirt or foreign objects on the surface can cause sensor failure"), and foreign objects on the sensor surface should be removed as requested. When sensors malfunction, both PCW and AEB will be unavailable. After the fault is resolved, they will return to normal.
- If AEB is triggered, the brake pedal will become hard to press, and the driver may hear a "sizzling" sound due to considerable hydraulic pressure needed to push the brake caliper in a short period of time.

⚠ CAUTION!

- PEBS intervenes only when all doors are closed and the seat belts are fastened. The following conditions will prevent PEBS from activating:
 - » A door is left open or is ajar while the vehicle is in motion;
 - » A seat belt is not fastened or is unbuckled while the vehicle is in motion;
 - » The driver presses the brake pedal deeply;
 - » The driver slams on the accelerator pedal;
 - » The driver frequently presses the accelerator pedal and brake pedal alternatively while driving.
- PEBS may not always achieve optimal performance if:
 - » The front bumper is strongly impacted due to an accident or other reasons;
 - » Tyres are not properly inflated or excessively worn;
 - » Non-conforming tyres are installed;
 - » Anti-skid tyre chains are installed;
 - » A small spare tyre or emergency tyre repair tool is being used.
- Contact a BYD authorised dealer or service provider to calibrate the radar sensors if:
 - » Radar sensors have been removed;
 - » Four wheels have been re-aligned due to wheel deviation;
 - » A collision happens;
 - » The PEBS performance degrades or the instrument cluster indicates a system abnormality.

Safety Assist

Integrated Power Brake (IPB)

Integrated power brake (IPB) provides power assistance for vehicle braking as required according to the driver's braking demand. It can also provide advanced control functions such as ABS, EBD, TCS, VDC, CST, and CRBS to improve vehicle stability and comfort, as well as regenerative braking efficiency.

Anti-lock Brake System (ABS)

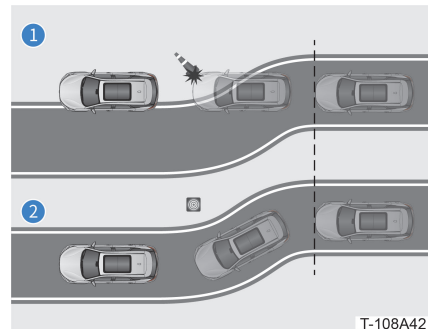

1 Without ABS



2 With ABS

ABS helps prevent wheel locking or slipping in emergency braking or when the vehicle is being driven on wet and slippery roads, so as to maintain steering control.

! WARNING!

- ABS is not designed to shorten the vehicle's braking distance. Be sure to maintain a safe distance from the vehicle ahead. The vehicle may require a longer braking distance than a vehicle without ABS if:
 - » The vehicle is running on a muddy road or one covered in gravel or snow;
 - » The vehicle is running with tyre chains;
 - » The vehicle is running on a bumpy road;
 - » The vehicle is running on an uneven road or one with many potholes.
- ABS may not work effectively if:
 - » The limit of tyre grip performance is exceeded (e.g. using over-worn tyres on a snowy road);
 - » The vehicle is running at high speeds on a slippery road.

! CAUTION!

- If both parking system fault warning indicator  and the ABS warning indicator  light up, park the vehicle safely and contact a BYD authorised dealer or service provider at once.
- ABS will not work when its fault warning indicator  is on.
- ABS cannot reduce the time or distance required for braking, it only helps with controlling steering when brakes are used. Always maintain a safe distance from other vehicles.

! CAUTION!

- ABS cannot prevent slipping caused by a sudden change of direction, e.g. trying to turn the steering wheel quickly or change lanes suddenly. Always maintain a safe speed while driving, regardless of the road or weather conditions.
- When running on spongy or uneven roads (e.g. roads covered in gravel or snow), vehicles without ABS may require longer braking distances than those with ABS. Should this occur, slow down and maintain a longer distance from other vehicles.

! REMINDER

- When ABS is functional, it is normal for the brake pedal to vibrate.

Electronic Stability Control (ESC)

The ESC system determines the driver's intention according to the steering wheel angle, vehicle speed, and other information, and constantly compares them with the actual driving conditions. If the vehicle deviates from its normal running route (e.g. skidding), ESC will correct it by applying braking forces to the corresponding wheels.

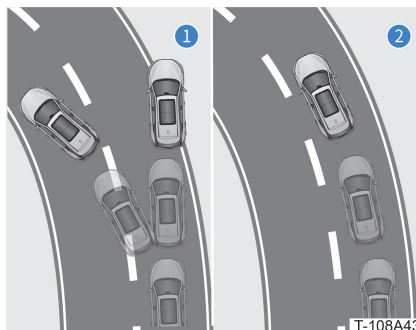

1 Without ESC

2 With ESC

If the vehicle begins to oversteer (i.e. drifting), ESC will apply braking forces to the front wheel near the outer side of the curve. If the vehicle begins to understeer (i.e. excessively large turning radius), ESC will apply braking forces to the rear wheel near the inner side of the curve. Vehicles not equipped with ESC may deviate from the normal driving route when skidding occurs. Vehicles equipped with ESC can be corrected according to the skidding amount to prevent route deviation.

Turning ESC On

ESC is turned on by default when the vehicle is started, and the ESC OFF warning indicator  on the instrument cluster is off.



With ESC turned off, tap on  /  > **DiPilot** or pull down the **Quick Settings** menu on the centre console touchscreen to turn **ESC OFF** off.

After ESC is turned off manually, it will automatically turn on when the vehicle speed exceeds 80 km/h.



After ESC is turned off manually, it will automatically turn on when the vehicle is restarted.

Activating ESC

With ESC on, if there is a risk of slipping or reversing when the vehicle is started on a slope, or if any driving wheel is idling, the ESC fault warning indicator  will flash, indicating that ESC has been activated and

is functional.

Turning ESC Off

Tap on  /  > **DiPilot** or pull down **Quick Settings** menu to turn **ESC OFF** on. After ESC is turned off, the ESC OFF warning indicator  on the instrument cluster will light up.

CAUTION!

- Incorrect tyre specifications or suspension retrofitting will compromise the driving safety systems and may result in ESC faults.
- If different tyres are installed on the vehicle, ABS and ESC will not be functional.
- Contact a BYD authorised dealer or service provider for details on how to replace tyres or wheels.

REMINDER

- If the vehicle gets stuck in snow or mud, ESC may reduce powertrain power output to the wheels. Should this occur, it is recommended that ESC is turned off to get the vehicle out.
- When ESC is functional, it will not immediately execute the "OFF" command if it is turned off. Instead, it will execute the "OFF" command only after the active intervention control is completed.
- ESC ensures vehicle stability and driving force. Do not turn it off if not necessary.

Electronic Brakeforce Distribution (EBD)

When the vehicle is braking, EBD will automatically adjust the braking force distribution ratio of the front and rear axles

to improve braking efficiency and stability using ABS.

Traction Control System (TCS)

TCS prevents driving wheels from slipping during acceleration by reducing motor power. If necessary, TCS will apply braking forces for the purpose of control, so as to prevent the slipping of driving wheels. Under unfavorable running conditions, TCS makes the vehicle easier to start, accelerate, and go uphill.

! WARNING!

- When the vehicle is running on a wet and slippery road, TCS may be unable to control the direction and meet the power output requirements, even if it is functional.

Vehicle Dynamics Control (VDC)

When the running vehicle takes a sudden turn, the VDC system will ascertain the intent of the driver according to the steering wheel angle and the vehicle speed and will continuously compare that information with actual vehicle conditions. If the vehicle deviates from the normal running route, VDC will make corrections by applying braking forces to the corresponding wheels to help the driver maintain control in case of skidding, and maintain the vehicle's directional stability.

Hydraulic Brake Assist (HBA)

When the driver quickly presses the brake pedal, HBA can identify that the vehicle is experiencing an emergency and will quickly increase the braking pressure to the maximum value. ABS will therefore be activated more quickly to shorten the braking distance.

Brake Override System (BOS)

BOS allows the driver to stop the vehicle by pressing the brake pedal even while pressing the accelerator pedal.



Hill Descent Control (HDC)

HDC uses active braking to help with driving uphill and downhill at low speeds. When HDC is active, ABS is activated once the wheels slip enough to trigger it to help with driving downhill or reversing safely and smoothly.

Turning HDC On/Off



Pull down the **Quick Settings** menu on the centre console touchscreen and tap on  to turn HDC on/off.

- When HDC is on, this button will be on blue and the HDC ON indicator  on the instrument cluster will light up.
- When HDC is activated, the HDC ON indicator  on the instrument cluster will flash.
- When HDC is off, the HDC ON indicator  on the instrument cluster will go out.

! CAUTION!

- In some special cases, such as driving down a long hill, HDC may be temporarily unavailable due to brake overheating. HDC will not resume its function until the brakes cool down.

REMINDER

- HDC automatically turns off when the vehicle speed exceeds 65 km/h.
- HDC works within the range of approximately 11-38 km/h. Within this range, the accelerator or brake pedal can be pressed or released to adjust vehicle speed.

Controlled Deceleration for Parking Brake (CDP)

When the EPB switch is pulled up, CDP will engage and the vehicle will brake at a constant deceleration (the deceleration will be 0.4g if only the EPB switch is pulled up and 0.8g if the EPB switch is pulled up and the brake pedal is pressed at the same time) until the vehicle comes to a stop. If EPB is released, CDP will stop functioning.

Hill Hold Control (HHC)

When the vehicle is started on a slope, HHC can maintain brake pressure for 1 second to prevent the vehicle from sliding backward after the brake pedal is released.

WARNING!

- When the vehicle is started on a steep slope, the vehicle may slip. Therefore, never rely solely on HHC. Be mindful of safe driving.

Brake Disc Wiping (BDW)

When the wiper switch is turned on or rain drops are detected by the rain sensors, IPB will apply a small brake pressure to the four brakes so the brake pads make contact with the discs. The water film on the brake discs is then removed to reduce the brake response time, and shorten the braking distance.

REMINDER

- As long as the system detects rain drops or the wiper signal is ON, the brake disc will be regularly wiped at certain intervals to improve safety.

Cooperative Regenerative Braking System (CRBS)

The CRBS system combines motor energy regeneration torque and hydraulic braking torque to form the braking torque required by the driver. When the driver presses the brake pedal, the motor energy regeneration torque and the hydraulic braking torque will continuously cooperate to meet any necessary braking requirements.

Electronic Brake Pre-charging (EBP)

EBP will monitor the status of the accelerator pedal through the IPB system to pre-build pressure for the braking system, so as to shorten the response time of the braking system and improve driving safety.

Roll Movement Intervention (RMI)



When the vehicle turns, RMI will determine if there is a risk of rollover by monitoring the movement of the vehicle. If any risk is detected, braking will be applied to one or more wheels to decelerate and avoid rollover.

Comfort Stop (CST)

CST integrates the brake pedal adjustment and comfort stop functions to provide a more comfortable driving experience.

Brake pedal adjustment: the brake pedal mode is used to adjust how the driver feels the brake pedal on their foot. Changes in brake pedal pressing depth as a function of

the vehicle deceleration vary according to different brake pedal modes.

Tap on  /  > **Vehicle Settings** > **Driving Comfort Adjustment** on the centre console touchscreen to set the brake pedal adjustment mode as **Standard** or **Comfort**.



Comfortable parking: in case of deceleration and stopping in normal situations, the suspension pitch and impact when decelerating are reduced by controlling the braking pressure of all four brakes to bring the vehicle to a smooth stop.

Tap on  /  > **Vehicle Settings** > **Driving Comfort Adjustment** on the centre console touchscreen to turn the **CST** on/off.

Acoustic Vehicle Alerting System (AVAS)

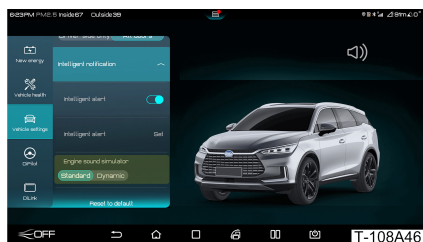
In order to prevent incidents, the vehicle will issue an acoustic prompt when running at low speeds to alert surrounding pedestrians, cyclists, drivers, etc.



Tap on  /  > **Vehicle Settings** > **Intelligent Notification** on the centre console touchscreen to set **Engine Sound Simulator** as **Standard** or **Dynamic**.

When the vehicle is in Reverse, a continuous warning sound will sound.

When the vehicle is in Drive:

- If the vehicle speed is above 0km/h up to 20km/h, the warning sound will become louder as the vehicle speed increases.

- If the vehicle speed is above 20km/h up to 30km/h, the warning sound will become softer as the vehicle speed increases.
- If the vehicle speed is above 30 km/h, the warning sound will stop automatically.

Airbags

Protection function of airbags

When the vehicle suffers any severe impact that could potentially cause injury to driver and/or passengers, the airbags will quickly be deployed and inflate. Airbags and the seat belts work in tandem to reduce the risk of serious injury to occupants in the event of an accident.

Make sure to carefully read and follow the precautions below.

WARNING!

- Be sure to fasten seat belts correctly.
- Improperly protected infants, toddlers and young children may sustain serious or even life-threatening injuries due to airbag deployment. Children must be properly protected with child protection devices.
- Do not place, install or stick anything in the dashboard panel or steering wheel airbag areas. Doing so can launch these objects at occupants when the frontal airbags deploy, causing serious and potentially life-threatening injuries.
- Do not use seat accessories that may obstruct the deployment of the front seat side airbags, cause system failure or accidental deployment, resulting in serious and potentially life-threatening injuries.

! WARNING!

- Do not hang coat hangers or other hard objects from the roof or the roof handles. These objects may be ejected when the side curtain airbag deploys, causing serious and potentially life-threatening injuries.
- Do not touch any airbag part immediately after their deployment to avoid scalding.
- If occupants have difficulty breathing after airbag deployment, either open the door or window for ventilation, or leave the vehicle before ensuring the environment is safe. Wash off any residue as soon as possible to avoid skin irritation.

! CAUTION!

- Do not hit the area where the airbag components are located or apply excessive force to these areas, as doing so may cause the airbag to fail or deploy.
- Contact a BYD authorised dealer or service provider if any airbag is damaged.

Front Seat Frontal Airbags

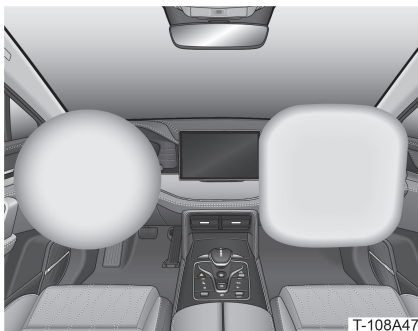

The front seat airbags are installed in the steering wheel and dashboard panel, and

marked with the lettering "AIRBAG".

In the event of a head-on collision that meets the necessary frontal airbag deployment conditions, the frontal airbags will deploy to protect the head and chest of the occupants.

Front Seat Side Airbags



The front seat side airbags are installed on the side of the driver and front passenger seat backrests, and are marked with the lettering "AIRBAG".

In the event of a side collision that meets the necessary side airbag deployment conditions, the side airbags will deploy to protect the occupants.

Side Curtain Airbags



The side curtain airbags are installed on the lower left and right edges of the roof, and are marked with the lettering "CURTAIN

AIRBAG".

In the event of a moderate to severe side collision of the vehicle that meets the necessary side curtain airbag deployment conditions, the side curtain airbags will deploy to help protect the occupants heads.

Airbag Deployment

In the event of a collision, the decisive factors for airbag deployment are vehicle speed and collision angle. The type of accident, obstacles, and other factors are also taken into consideration.

When airbags deploy:

- The airbag will deploy (inflate) at a very high speed, so it may cause slight scratches and burns.
- It will produce a loud noise and spray a powdery substance.
- The airbag areas and airbags may become very hot.
- The windscreen may be broken.
- The HV power supply of the vehicle will automatically cut off.
- The vehicle will automatically unlock.
- Hazard warning lights will be on.

Airbags may deploy if:



The front end of the vehicle hits the ground after passing over a deep pothole;



The vehicle hits a kerbstone or other protruding objects;

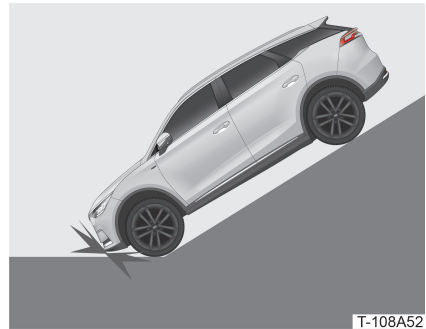

The front end of the vehicle hits the ground when the vehicle is going downhill;

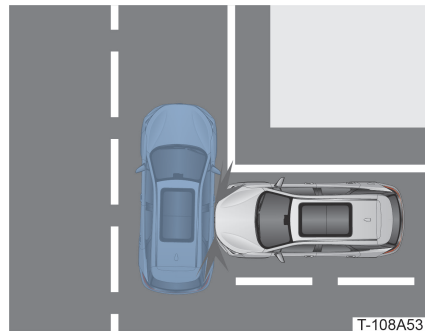

The vehicle suffers a lateral collision by another vehicle.

Airbags may not deploy if:

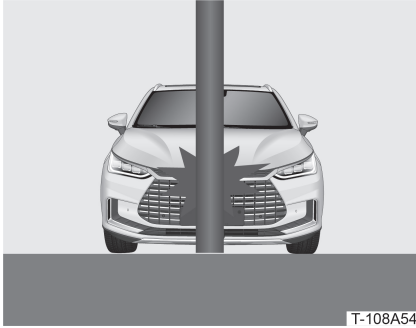

The vehicle hits a concrete column, tree or any other long and slender object;



The vehicle hits the lower rear part of a truck;



The vehicle suffers a rear-end collision by another vehicle;



The vehicle rolls over;



The vehicle hits a wall or another vehicle on a part other than the front;

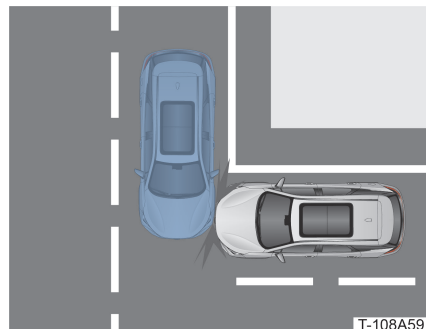

A part other than the cabin of the vehicle suffers a lateral collision;

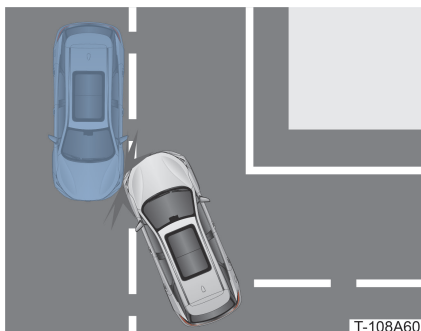

T-108A60

A side of the vehicle suffers an oblique collision;

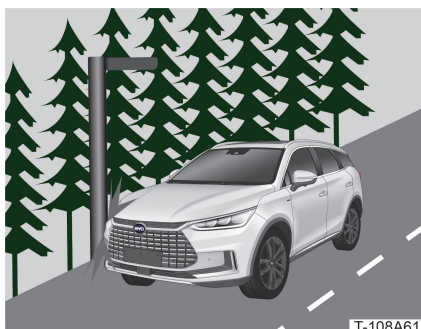

T-108A61

The vehicle hits a roadside post.

SRS Warning Indicator



T-108A62

When the vehicle is powered on, the system will conduct a self-inspection. The SRS fault warning indicator will light up for a few seconds and then automatically go out, indicating that SRS is functional. If the fault

warning indicator does not go out after turning on or remains lit up while driving, along with a text prompt on the instrument cluster, this indicates that SRS has failed.

! CAUTION!

- Please contact a BYD authorised dealer or service provider if the SRS system has failed.

Checking SRS

Check the SRS system regularly.

- Check if the SRS Fault warning indicator works normally.
- Check the airbag for scratches, cracks or any other damage.
- Check if any objects are placed, installed, or stuck to the airbag deployment path.

Replacing SRS system components

Read and follow the precautions below when replacing SRS components.

! WARNING!

- The airbag can only be triggered once.
- Do not modify, disassemble or discard SRS.

! CAUTION!

- It is recommended to contact a BYD authorised dealer or service provider for maintenance or replacement of the SRS system if:
 - » An airbag has been deployed;

⚠ CAUTION!

- » The front of the vehicle is damaged or deformed, or the vehicle suffers an accident that is insufficient to cause the front seat frontal airbags to deploy;
- » The doors and surrounding areas are damaged or deformed, or the vehicle has an accident that is insufficient to cause the side airbags and the side curtain airbags to deploy.

Tyre Pressure Monitoring System (TPMS)

TPMS collects information about tyre pressure and temperature in real time through the sensors installed in the wheels. When abnormalities are detected, the tyre pressure fault warning indicator  will light up.

Tyre Pressure Display

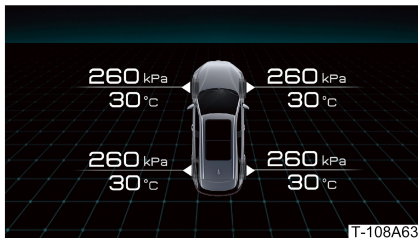

If no tyre pressure fault is displayed on the instrument cluster, the tyre pressure information can be accessed on the instrument cluster menu - driving information. Tyre pressure information includes:

Tyre pressure: current real-time pressure of each tyre.

Temperature: current real-time temperature of each tyre.

Warning Information

When TPMS detects low tyre pressure or high tyre temperature, the tyre pressure fault warning indicator  on the instrument cluster will light up and there will be a text prompt of the relevant fault information.

Alarms	Descriptions
The warning indicator stays on and the tyre pressure value is displayed in yellow.	Low tyre pressure
The warning indicator stays on after flashing and the tyre pressure value is displayed as an abnormal signal.	Abnormal signal
The warning indicator stays on after flashing and the tyre pressure value is displayed as an abnormal signal. At the same time, a text prompt appears reading "Check the TPMS".	System fault

Low tyre pressure: check the corresponding tyre for air leakage and refill it to its correct pressure (refer to **Vehicle Information - Specifications - Wheels and Tyres Specifications**).

Abnormal signal: contact a BYD authorised dealer or service provider.

System fault: contact a BYD authorised dealer or service provider.

When the tyre pressure fault warning indicator  on the instrument cluster is on, the following can be done:

Cancel alarm: press the right roller on the steering wheel to cancel the alarm. If the fault is not resolved, the instrument cluster will relay the alarm information the next time the vehicle is started.

Check tyre pressure fault information: rotate the right roller on the steering wheel to check the tyre pressure warning details of each tyre.

! WARNING!

- To avoid accidents, do not continue driving when the tyre pressure fault warning indicator is on.

! CAUTION!

- If the tyres or sensors need to be replaced, or the tyre positioning needs to be changed, contact a BYD authorised dealer or service provider.
- Contact a BYD authorised dealer or service provider in case of TPMS failure.

Driving in Harsh Weather

Driving in Fog

When driving in foggy conditions, read and follow the precautions below.

! WARNING!

- Check the vehicle's lighting system, such as the front and rear combination lights and rear fog lights before driving, to prevent accidents and personal injury.
- Fog makes for poor visibility, which considerably increases the risk of traffic accidents. Limiting travel plans on foggy days is recommended.

! WARNING!

- Turn on the fog lights and control the vehicle speed when driving in fog. Sound the horn whenever necessary to remind pedestrians and other vehicles.
- When you hear a horn from another vehicle, sound your horn immediately to signal the location of the vehicle.
- Try to drive in the middle of the road and do not drive along the roadside in order to avoid colliding with parked vehicles.
- Before driving on foggy days, all of the vehicle's lights should be checked comprehensively. When driving, the rear fog lights, clearance lights and low beam must be turned on. This will increase visibility and allow better visibility of vehicles, pedestrians and road conditions, as well as their visibility of your own vehicle.
- Do not slam on or quickly release the accelerator pedal. Do not brake suddenly or turn the steering wheel sharply. To control the vehicle speed, first release the accelerator pedal slowly and then gently press the brake pedal to prevent a rear-end collision.

! REMINDER

- Control vehicle speed and obey all local traffic regulations.

Driving in Rain

! WARNING!

- Control vehicle speed. Rainy weather makes for poor visibility and slippery roads, thus greatly increasing the risk of traffic accidents and injuries.

! WARNING!

- Do not slam on or quickly release the accelerator pedal. Do not brake suddenly or turn the steering wheel sharply. To control vehicle speed, first release the accelerator pedal slowly and then gently press the brake pedal.
- Sudden braking, acceleration, and sharp turning on slippery roads are likely to cause the vehicle aquaplane and lose control. Make sure to drive carefully.
- When it rains, clean the side mirrors or turn on their heaters to prevent blind spots.
- Turn on the fog lights and low beam.
- If heavy rain or thunderstorms prevent the vehicle from moving forward, park safely at a place where there is no risk of flooding. Turn on the hazard warning lights.

! CAUTION!

- After the rain, the vehicle should be cleaned as quickly as possible to prevent acidic rain water from corroding the paint.
- Before driving over waterlogged road stretches, their depth must be ascertained. The depth of any waterlogged stretch must not exceed the lower edge of the vehicle body.
- After driving off a waterlogged area, gently press the brake pedal to check if the brakes are functioning normally. When the brake pads are wet, braking will suffer a clear decrease in performance.

Driving in Hot Weather

! WARNING!

- Do not wear slippers or high heels to drive. In summer, tyre pressure will rise with temperature, so tyres are more prone to bursting.
- When parking, check for any dangerous or flammable materials around the vehicle.
- Avoid exposing the vehicle to intense sunlight during the hot season, and do not carry flammable or explosive substances such as lighters, paper scraps, cloth toys, perfumes, etc. in the vehicle.

Driving in Cold Weather

! WARNING!

- In the cold season, make sure to carefully check the vehicle safety devices such as steering wheel, brakes, lighting, dashboard, horn, wipers, etc. before driving.
- Roads are slippery after snowfall. Maintain a stable speed and do not make any quick movements like sudden acceleration, braking, and steering. Accelerate steadily and keep the vehicle at medium to low speeds.
- Start and accelerate gently to prevent skidding and sideslips.
- Check the condition of the 12V battery (starter Fe battery) frequently and keep it fully charged.
- Have some spare tools ready for use in case of emergency. These can include: anti-skid chains, windscreen scrapers, sand bags, and emergency flashers.

! CAUTION!

- Park where there is no snow or water to prevent water from freezing and tearing the wheels.
- Place a wood board under the tyres to protect them from snow.
- Avoid parking under trees to prevent damage from falling ice.
- After parking, lift the wiper arm to prevent it from freezing onto the windscreen, which may cause tearing or damage to the motor.

Using Anti-Skid Chains

Install anti-skid chains on the front and rear wheels before driving in harsh environments such as snowy or icy roads.

! WARNING!

- Anti-skid chains should be installed on the front and rear wheels in pairs.
- Never drive at speeds exceeding 30 km/h or the speed specified for the anti-skid chains, whichever is smaller. Do not speed, accelerate, decelerate or turn sharply.
- When decelerating, use the brake pedal correctly. Sudden braking on snowy or icy roads will cause the vehicle to skid, drift or slip. Maintain a safe distance from the vehicle ahead, and gently press the brake pedal when needed. Note that the anti-skid chains installed on the tyres can provide the proper amount of friction, but cannot completely prevent skidding.
- Using anti-skid chains that are not up to specifications will adversely affect the performance and safety of the vehicle.

! CAUTION!

- Do not use anti-skid chains on dry ground. Remove anti-skid chains once road surfaces are free from ice or snow.

! REMINDER

- Follow local regulations before fitting on tyre chains.

Trip Record

Dashcam

Interface Introduction



1 Menu bar

Real-time images, playback list and settings can be switched.

2 Menu bar function

Video recording, photo-taking and video locking are available.

3 Image area



Images in front of the vehicle can be displayed.

Real-time Image

Video Recording

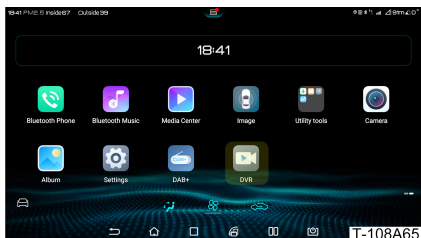
1. Install an SD card.
2. Tap on the  button on the main interface of the centre console touchscreen to enter the dashcam interface.



3. Select the video recording button  in the function menu bar for the dashcam system to start recording images that are in its front in real time.
4. Tap on the video recording button  again to stop the video recording. Recorded videos can be viewed in the playback list.

REMINDER

- The vehicle is not equipped with an SD card, which must be purchased and installed on your own. (Refer to **Ride - Comfort Ride - SD Card Slot**).

Taking Photos

Tap on the  button on the dashcam interface to take photos. The system will take photos of the images in front of the vehicle and store them in the SD card.

Locking Videos

Tap on the  button on the dashcam interface to lock the first 20 seconds to the last 10 seconds of the currently recorded videos.

Locked videos can be viewed by tapping on **DVR > Playback > Lock Video** on the centre console touchscreen.

REMINDER

- Locked videos will not be overwritten.

Playback List

Recorded travel videos, locked videos and photos taken can be viewed.

Settings

Video recording duration, recording resolution, and delete data can be set.

REMINDER

- Once deleted, data cannot be recovered. Please think twice before deleting any data.

In-Vehicle Camera



The in-vehicle camera is used for some apps whenever they need to be called via the centre console touchscreen. The camera lens cover can be closed when not needed.

! REMINDER

- For privacy reasons, the in-vehicle camera is turned off, and only enabled when required through the centre console touchscreen.

10km/h Speed Lock

Speed Sensing Auto Lock

When the vehicle speed exceeds approximately 10 km/h, all doors will automatically lock.

Regenerative Braking



This vehicle is equipped with regenerative braking, which uses a motor to convert the kinetic energy generated by the vehicle while braking or coasting into electric energy. This energy is then stored in the high-voltage battery, thereby improving the vehicle's driving range.

Operation method



When the vehicle is powered on, push or pull the energy regeneration lever to select the larger or standard regenerative braking

mode. After setting, the instrument cluster will display the set mode.

Alternatively, pull down **Quick Settings** menu or tap on  /  > **New Energy** > **Energy Flow** to choose **Larger** or **Standard** as the regenerative braking mode.

! REMINDER

- When the AEB system is triggered or the brake pedal is quickly pressed to a certain depth, the vehicle will brake first and no energy will be gained through regenerative braking.

0-100 km/h: Full Throttle Experience

Full throttle can be achieved when:

- The high-voltage battery SOC is 95% or above;
- The vehicle is in SPORT mode. (Refer to **Driving - Pulling Out of Parking Spaces - Driving/Terrain Mode Switching**.)
- Bring up the acceleration timer interface in the menu information. (Refer to **Driving - Getting to Know the instrument cluster - instrument cluster Control**.)

! WARNING!

- Be mindful of all relevant safety measures when experiencing this function.
- Before experiencing this function, check if tyre, brake and other vehicle functions are in optimal conditions.
- Do not use this function when visibility is low (e.g. dust, haze and at night).

 **WARNING!**

- Do not use this function on slippery, snowy, muddy, or water-logged roads, nor on grass, sand, etc.
- Do not use this function on roads with complex traffic environments (e.g. at junctions, with pedestrians or other traffic participants).
- Do not use this function before you are fully familiar with the vehicle, so as to avoid accidents.

09

PARKING

Side Mirror Auto-Tilt	130
Park Assist	130
Panoramic View	131

Side Mirror Auto-Tilt

When this feature is turned on, both side mirrors automatically tilt downward when reversing to improve the view of the lower area on each side of the vehicle.

Operation method

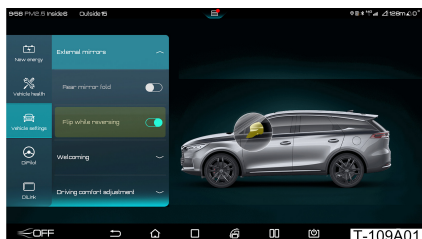

The **Auto-Tilt** feature can be turned on/off when the vehicle is powered on by tapping on / > **Vehicle Settings** > **Side Mirror Auto-Tilt** on the centre console touchscreen.

With the feature turned on, shift into "Reverse", and both side mirrors automatically tilt downward to a set angle.

Park Assist

The Park Assist System is designed to assist in reversing by using 8 radar sensors in the front and rear of the vehicle. While parking, the Park Assist System informs the distance between the vehicle and an obstacle through images displayed on the centre console touchscreen and beeps to alert of close objects.

Operation method

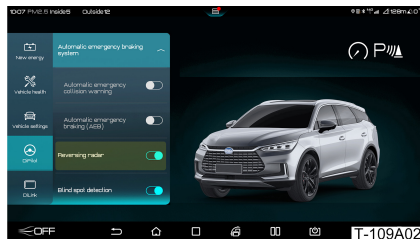

- The **Park Assist** feature can be turned on/off by tapping on / > **DiPilot** or pulling down the **Quick Settings** menu to select **Park Assist** on the centre console touchscreen.
- The Park Assist System turns on automatically whenever "Reverse" is shifted into.



REMINDER

- When reversing, the touchscreen automatically displays the "Panoramic View" interface.
- When reversing is cancelled, the screen returns to the previous image.

Sensor position and detection range

Sensor position	Detection range (mm)
Both front sides	600
Front centre	1200
Both rear sides	600
Rear centre	1200

Working state

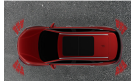
Distance (mm)	Image	Beep
~700-1200		Slow
~300-700		Fast
~0-300		Constant
~300-600		Fast
~0-300		Constant

When driving at speeds below 10 km/h with the Park Assist System on, a beep will be heard if the sensor detects an obstacle within its range.

Beeping becomes faster as the vehicle moves closer to the obstacle. When the distance is within about 0.3m, the beeper sounds at a constant tone. At this point, stop the vehicle to avoid collision.

System Limit

The system may not detect obstacles when:

- Sensors are covered by or attached to foreign objects.
- Obstacles are wires, fences, ropes, or other small items.
- Obstacles are acute reflectors or cone

shaped objects.

- Obstacles are cotton, snow, materials which absorb radio waves, objects whose surfaces do not reflect detection signals, or clothing with such characteristics is worn.
- There is ultrasonic noise in the same frequency, such as metal noise, high-pressure gas emission noise, vehicle horn sounding against the sensor, etc.
- Reversing is taking place on a slope.
- Driving on grass or bumpy roads.
- Driving in harsh weather.

WARNING!





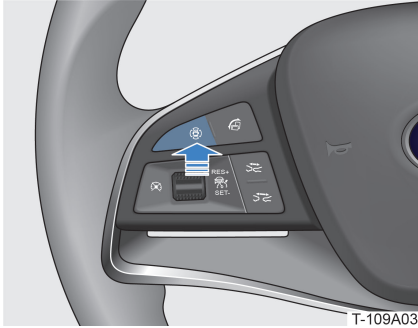

- The Park Assist System is for guidance purposes only and cannot ensure that all obstacles are detected under every circumstance. When parking, always check the surroundings.
- Do not have high-pressure water or steam come into direct contact with the sensors when washing the vehicle, as doing so may damage them.

Panoramic View

The Panoramic View System captures real-life images around the vehicle with four cameras placed outside. A specific algorithm builds the panoramic view and displays it in the centre console touchscreen. The vehicle surroundings are displayed in real time, and blind spots are reduced. This feature also allows predicting the vehicle's motions with the help of the steering wheel angle, vehicle size, and other parameters. This information is then superimposed on the Panoramic View to help the driver better understand the current conditions for safe driving.

Turning Panoramic View on/off



- Press the  button on the left side of the steering wheel to turn the Panoramic View System on/off.
- When shifting into Drive, the Panoramic View System turns on automatically.
- When shifting into Drive and/or turning on the left/right turning light, the Panoramic View System turns on automatically. The **Steering Linkage** feature can be turned on by tapping on  /  > **DiPilot** > **Panoramic View** on the centre console touchscreen.
- When the Park Assist System is triggered, the Panoramic View System turns on automatically. The **Radar Trigger Panoramic View** feature can be turned on by tapping on  /  > **DiPilot** > **Panoramic View** on the centre console touchscreen.
- Whenever the vehicle exceeds the speed limit, the Panoramic View System turns off automatically.
- Tap on the  button on the home screen to enter the Panoramic View interface.

Interface

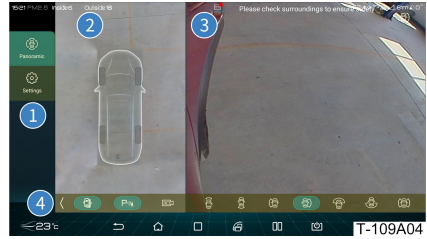

1 Menu

Views can be switched from front, rear, left, and right of the vehicle under the Panoramic View mode or by setting the menu.

2 Top View Area

Tap on the view icons on this interface, and the individual corresponding views are displayed in the image area.

3 Image

The real-time view outside the vehicle at a set angle can be displayed in this area.

4 Function Menu

The vehicle status and viewing angle in the top view area and the image area can be set.

Viewing Angle Switching

Auto Switching

When shifting into Drive:

- The image displayed switches to the front view automatically.
- When turning on the left turning light, the image displayed switches to the front left wheel image automatically.
- When turning on the right turning light, the image displayed switches to the

front right wheel image automatically.

When shifting into Reverse, the image displayed switches to the rear view automatically.

Manual Switching

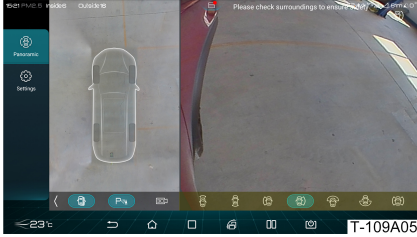

Tap on the Viewing Angle icon to enter the corresponding viewing angle mode.

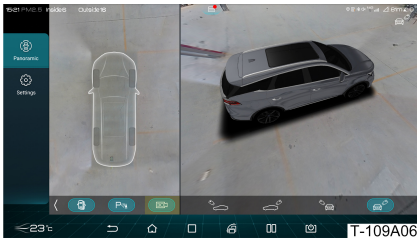

Tap on the  button to enter 3D Panoramic View mode. In 3D mode, touch and drag the vehicle image or tap on the Viewing Angle icon on the lower right to switch between viewing angles.

Park Assist

Tap on the  button to turn the Park Assist System on/off.

With this feature turned on, the image displays a warning when the vehicle approaches an obstacle. Please refer to the **Parking - Park Assist** section.

Transparent Panoramic View

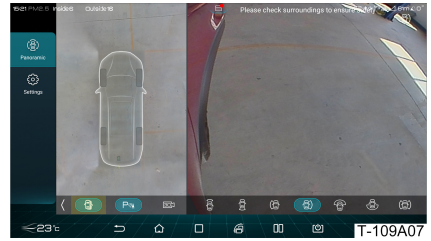

Tap on the  button or the Top View Area to switch between physical vehicle mode and transparent vehicle mode.

In transparent vehicle mode, the road surface underneath the vehicle can be viewed in the top view area.

REMINDER

- Never depend on the Panoramic View while driving as this feature does not allow for real-time imaging and the image interface cannot fully reflect the environment underneath the vehicle.

Function Settings

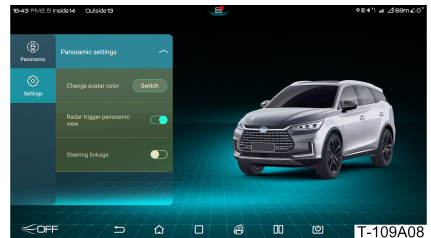

Change Avatar Colour

Tap on "Switch" to switch the Colour of vehicle body in the view.

Radar Trigger Panoramic View

With this feature turned on, when driving at speeds below 10 km/h with the Park Assist system activated, the Park Assist System

and Panoramic View System will turn on automatically if the sensor detects an obstacle within detection range.

Steering Linkage

Activating this feature will cause the Panoramic View System to turn on automatically whenever shifting into Drive and/or turning on the turning light.

WARNING!

- As the Panoramic View System uses wide-angle fisheye cameras, objects on the display screen may appear distorted.
- The Panoramic View System is for parking/driving assistance only. Always check the surroundings when parking/driving to avoid accidents.
- Do not use the Panoramic View System unless the side mirrors are fully extended and the doors are closed.
- Drivers must use multiple approaches to judge the distance between the vehicle and objects, as objects displayed on the "Panoramic View" interface are potentially different from what they may appear, especially when the vehicle is moving closer to objects.

CAUTION!

- Cameras are installed on the front grille, under the left/right side mirrors, and above the rear license plate. Make sure that the cameras are unobstructed.
- Do not have high-pressure water or steam come into direct contact with the cameras when washing the vehicle, as doing so may damage them.

REMINDER

- In the event the vehicle is started and the infotainment system is not yet fully activated, the "Panoramic View" display interface will either have a delayed reaction or the screen will flash whenever the Panoramic View start button is pushed or the vehicle is shifted into Reverse. This is the normal power-on process for the cameras, and is no cause for concern.
- Whenever the vehicle is moving at a low speed, there may be misalignment between the image underneath the vehicle and the image outside the vehicle due to the transparent panoramic view being affected by changes in vehicle speed or frequent braking.

10

EXITING

Getting Ready to Exit	136
Unlocking from Inside	136
Exiting Courtesy	137
After Exiting	137

Getting Ready to Exit

Closing Windows

Please refer to the **Ride - Driver Window Controls - Driver Window Controls** section.

Closing Sunroof

Please refer to the **Ride - Comfort - Panoramic Sunroof/Sunshade** section.

Powering Off

Normal

1. Press the brake pedal, stop the vehicle, and press the "P" gear button to shift to Park.
2. Press the "START/STOP" button to power off.



Remote control

1. Press the brake pedal, stop the vehicle, and press the "P" gear button to shift to Park.
2. Press and hold the remote Start button  to power off the vehicle from the outside.



CAUTION!

- If the electronic parking brake (EPB) fails to apply automatically when shifting into Park, contact a BYD authorised dealer or service provider.

Unlocking from Inside

Auto Unlocking

When the vehicle powered off, all doors unlock automatically.

Unlocking with the "Unlock" Button



Press the  button to unlock all doors.

Unlocking with the Interior Door Handle

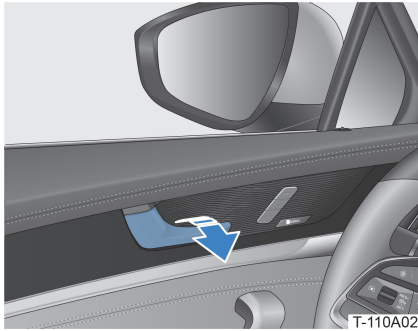

With doors locked:

Pull the interior door handle to unlock the corresponding door.

Pull the interior door handle again to open.

With doors unlocked:

Pull the interior door handle to open the corresponding door.

! REMINDER

- When the child protection lock is activated, rear doors cannot be opened by pulling their interior handles.

Exiting Courtesy

When the vehicle is powered on, tap on  /  > **Vehicle Settings** > **Exiting Courtesy** on the centre console touchscreen to select your desired mode.

With this feature enabled, the steering wheel retracts and the driver seat slides backwards when the vehicle is powered off and the front left door is opened, so exiting is made easier.

After Exiting

Open Window/Sunroof Alarm

When the vehicle is powered off and the front left door is opened, a beep will be heard and a message of "Windows left opened/Sunroof left opened" will be displayed on the instrument cluster if any window or the sunroof has been left open.

11

CHARGING

Charging Instructions	140
Charging Port	143
AC Charging	144
DC Charging	146
Smart Charging	146
Compatibility of Vehicle and Charging Infrastructure	147

Charging Instructions

Charging Precautions

- Children should be supervised when in the vicinity of plugged-in charging equipment.
 - Charge the vehicle in a safe environment (away from fire or heat sources).
 - Inspection and procedure before charging:
 - » Make sure there are no abnormalities with the power supply equipment, charging connector, charging port, adapter, etc., such as cable wear, port rust, shell rupture or foreign substances in the port.
 - » Do not charge when the metal terminal of the power plug/outlet or the charging connector/port is damaged or loosely connected due to rust or corrosion. Contact a BYD authorised dealer or service provider.
 - » When there is obvious staining or moisture on the power plug/outlet or charging connector/port, please wipe it with a dry, clean cloth to ensure that the joint is dry and clean.
 - Use only certified charging equipment specifically designed for electric vehicles:
 - » Do not attempt to modify, disassemble, or service the charging equipment yourself. There are no user serviceable parts inside.
 - » Uncertified products are strictly prohibited.
 - In order to avoid damage to charging equipment:
 - » Do not hit the charging equipment, or subject it to falls or collisions in order to prevent mechanical damage.
 - » Do not expose the charging equipment to heat.
 - When the state of charge (SOC) bar on the instrument is red, it indicates that battery power is about to run out. Charge the vehicle immediately. Failure to do so can reduce the battery life and jeopardise the driving experience.
 - To ensure safety, it is recommended that the vehicle is powered off before charging.
 - To reduce the risk of electric shock, never operate equipment with wet hands.
 - Inserting Charging Connector before Charging:
 - » Make sure that there are no foreign objects in the charging connector and charging port, and the electric shock protection cap of the charging connector terminal is not loose or deformed.
 - » While holding the charging connector, aim it at the charging port and push it in. Check to ensure it is properly inserted.
 - If there is anything abnormal about either the vehicle or charging equipment when charging, stop immediately and contact a BYD authorised dealer or service provider.
 - Do not conduct vehicle repairs or testing while charging.
- When charging, the following precautions must be taken in order to prevent damage:
- » Do not shake the charging connector. Doing so may damage the charging port of the vehicle.
 - » Given the risk of lightning strikes, charging the vehicle during a thunderstorm is not recommended.
- Precautions During Charging:

- » In order to ensure proper charging power flow, it is not recommended that any of the vehicle's high-power electrical appliances - such as air conditioner - is turned on.
- » It is recommended that the vehicle is parked in a ventilated place when charging.
- Using the control box triangle hook: hang the hook after charging to prevent damage to the charging cable.
- The charging system stops automatically when the battery is fully charged.
- To interrupt charging, it is necessary to first turn off the power supply equipment before disconnecting the charging adapter.
- Pulling Out Charging Connector After Charging:
 - » Stop charging and unlock the charging connector.
 - » Hold the charging connector and pull it out horizontally.
 - » Do not forcibly pull out the charging connector when the charging port lock is activated. Doing so may damage the charging port.
- After the charging connector is unplugged, reinsert the charging port protection cover and close the port hatch.
- Make sure the charging equipment has been disconnected before powering on the vehicle.
- If the vehicle has not been used for an extended period of time (over one month), it is recommended that it is fully charged before driving in order to prolong the battery life. It is also recommended that vehicle is charged once a month whenever it is not in use.
- When the battery is found to be too hot or too cold, the system automatically activates the battery cooling or heating

function.

- When the battery cooling or heating function is activated, it is normal for the charging time to be slightly delayed and the charge to increase slightly.
- The time required for a full battery charge varies according to the charging mode, SOC, battery temperature, service time, ambient temperature, and other conditions.
- If the charging port hatch is frozen and cannot be opened, use hot water to open it, do not force it open.
- In hot weather, charge the vehicle in a cool and ventilated place.



CAUTION!

- When the charging port hatch is locked, do not force it open.
- When the charging port protection cover is fully open, do not close the charging port hatch.

Charging Mode

To avoid battery power loss, thus compromising driving experience, it is very important to promptly charge and estimate SOC requirement before driving.

The vehicle features the following charging modes:

- Scheduled charging (Charge the vehicle regularly at a scheduled charging time)
- Instant charging (Start charging immediately after the charging connector is connected or operated)



REMINDER

- Scheduled charging mode only supports AC charging.

Charging equipment

Household charging equipment

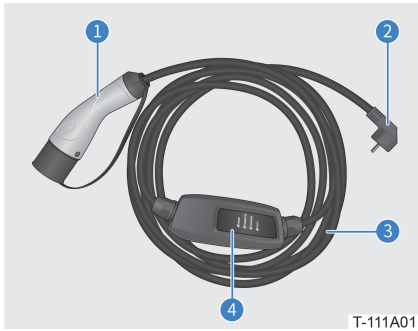

- 1 Charging Connector
- 2 Charging Plug
- 3 Charging Cable
- 4 Control box

Charging pile charger

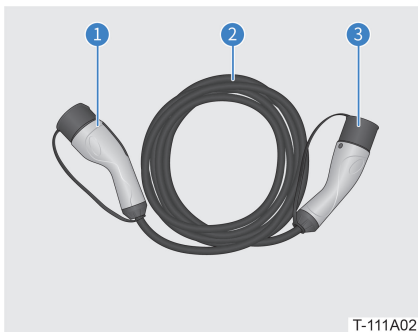



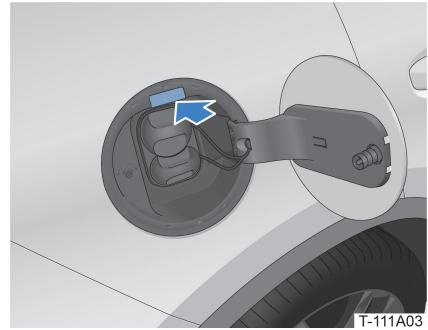

- 1 Vehicle's charging connector
- 2 Charging cable
- 3 Pile charging connector

Charging status indication

Charging port indicator



Colour	Status	Description
	Flash	Connecting for charging
	ON	Scheduled charging
	Flash	Charging
	ON	Charging completed
	ON	Charging fault





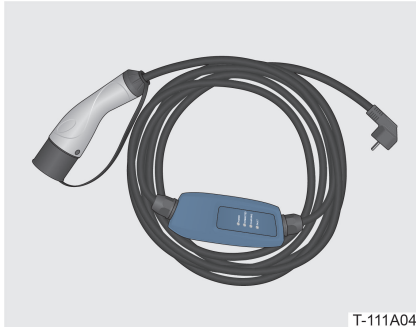

CAUTION!

- The charging connector cannot be pulled off when the charging indicator flashes yellow or is continually lit up.

Charging control box indicator



T-111A04

Colour	Status	Description
	ON	Powered on
	ON	Charging equipment connected
	Flash	Charging
	ON	Charging completed
	Flash	Overtoltage or undervoltage
	ON	Charging fault

Charging Port



T-111A05

The charging port is located at the rear right of the vehicle.

Unlock the vehicle, press the rear edge of the charging port hatch to open the charging port.

Close the charging port cap in place.



CAUTION!

- Make sure the charging port protection cover is inserted before closing the hatch.

11

CHARGING

Charging Port Lock

This vehicle features a charging port lock to prevent the charging connector from being taken away. It is recommended that this function is activated.

Activating Charging Port Lock



T-111A06

Tap on  /  > **New Energy** on the centre console touchscreen to activate the **Charging Port Lock** feature.

If the charging connector needs to be pulled out with this function activated, double press the remote control key unlock button  to pull it out.

Deactivating Charging Port Lock

The charging port lock function automatically deactivates when the vehicle is unlocked.

If the charging connector does not come out due to a charging port lock fault, it can be unlocked manually. Please refer to **Emergency - Owner's Emergency - Emergency Unlocking/Locking** section.

REMINDER

- Activating the charging port lock function is recommended when charging.

AC Charging

AC Charging with Household Charging Equipment

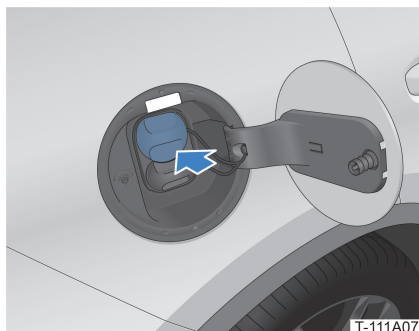

Charging with household charging equipment:

1. Power on.
 - Plug in the household charging plug into the power outlet.
2. Open the charging port hatch and remove the slow charging port protection cover.



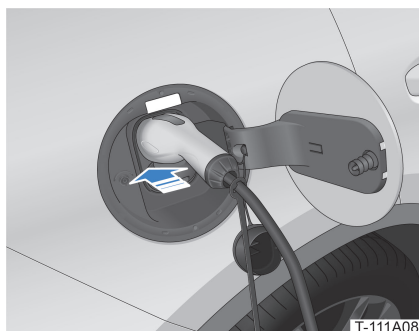

3. Insert the charging connector into the charging port.



4. Confirm connection:
 - The charging connector indicator  in the instrument is on.
 - The charging port indicator flashes green.
 - The charging control box indicator flashes green.
5. When charging is completed, double press the remote control key unlock button  and unplug the charging connector.
6. Unplug the charging plug.
7. Reinsert the charging port protection cover and close the hatch.
8. Pick up the charging equipment and store it properly.

AC Charging with Charging Pile Charger

1. Open the charging port hatch and remove the AC charging port protection cover.
2. Insert the vehicle charging connector into the charging port.
3. Insert the charging pile charging connector into its discharging port.
4. Power the charging pile on.
 - Power the charging pile on by following the charging pile operation instructions.
5. Confirm connection:
 - The charging connector indicator  in the instrument is on.
 - The charging port indicator flashes green.
6. End charging.
 - Power the charging pile off by following the charging pile operation instructions.
7. Unplug the charging pile charging connector.
8. Double press the remote control key unlock button  to unplug the charging connector.
9. Reinsert the charging port protection cover and close the hatch.
10. Pick up the charging equipment and store it properly.



REMINDER

- The method above is for general operation and may vary slightly according to the charging pile used. Follow the specific charging pile instructions.



Scheduled Charging

The instrument displays "Reminder: IGN OFF, hold and press  to set charging time" when the charging connector is connected or the vehicle is powered off. Schedule charging as follows:

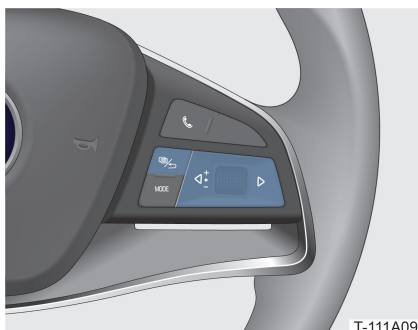
1. Open the charging port hatch and remove the AC charging port protection cover.
2. Insert the charging connector into the charging port.
3. Power on.
 - Method 1: Plug in the household charging plug into the power outlet.
 - Method 2: Power on the charging pile according to its operation instructions.
4. Set charging start time.



T-111A09

- Press and hold the  button on the right side of the steering wheel to enter the Scheduled Charging time setting interface.
 - Press  /  on the right side of the steering wheel to switch between hours or minutes.
 - Roll the right roller on the steering wheel up and down to set the start time for scheduled charging.
 - Press the right roller on the steering wheel to confirm the start time.
5. After the charging time is scheduled,

the instrument displays the "Scheduled Charging" countdown interface.

6. End charging.
 - Method 1: unplug the power plug.
 - Method 2: power off the charging pile according to its operation instructions.
7. Double press the remote control key unlock button  to unplug the charging connector.
8. Reinsert the charging port protection cover and close the hatch.
9. Pick up the charging equipment and store it properly.

REMINDER

- The charging connector can be connected before or after setting the scheduled charging time, but not after the scheduled time for charging to start.
- The scheduled charging function cannot be used if SOC is below 15%.



DC Charging

Charging in DC mode:

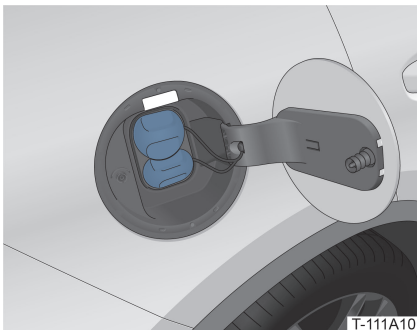
1. Open the charging port hatch and remove the two protection covers.



2. Insert the charging connector.

3. Power on the charging pile.
 - Power on the charging pile according to its operation instructions.
4. Confirm connection:
 - The charging connector indicator  in the instrument is on.
 - The charging port indicator flashes green.
5. End charging.
 - Power off the charging pile according to its operation instructions.
6. Double press the remote control key unlock button  to unplug the charging connector.
7. Reinsert the charging port protection cover and close the hatch.
8. Pick up the charging equipment and store it properly.

REMINDER

- The method above is for general operation and may vary slightly according to the charging pile used. Follow the specific charging pile instructions.

Smart Charging

In order to avoid power loss of the 12V battery (starter Fe battery), the smart charging function will activate and the power from the high-voltage battery is enabled to charge it when the following conditions are all met simultaneously:

- The bonnet is closed.
- The vehicle is powered off.
- Battery is allowed to discharge.
- 12V battery SOC is below stipulated limit.

REMINDER

- When the vehicle has been inactive for an extended period of time, the smart charging function may activate.
- Power for smart charging comes from the vehicle's high-voltage battery, which may reduce its SOC.

Battery Thermal Management While Charging*

When charging at low temperatures (below 5° C), the battery thermal management system activates automatically to ensure optimal temperature and charging performance.

When charging in AC mode, activate the battery thermal management system through the centre console touchscreen to keep the battery warm. The system enters battery warming mode after charging is completed, so keep the charging pile connected, for it will feed the battery thermal management system and keep the battery warm for up to 18 hours. This function should be activated on a case by case basis.

REMINDER

- When the ambient temperature is above 5°C , the battery thermal management system will not activate.
- If AC charging is interrupted for any reason before the vehicle is fully charged, battery thermal management will not take place.

Compatibility of Vehicle and Charging Infrastructure

The following signs in accordance with DIN EN 17186 provide information on whether the local power supply is suitable for the vehicle. The signs are located on the vehicle's charging socket, components of the local charging infrastructure (charging station, socket) and on the charging cable. The signs refer to standardized charging systems in accordance with DIN EN 62196.

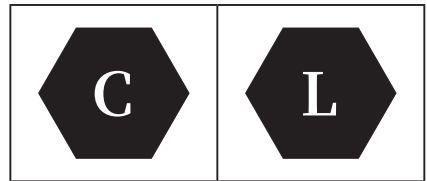

12

LOCKING



Locking from Outside	150
Anti-Theft Alarm.....	151
Folding/Unfolding Side Mirrors	152
Lighting after Exit & before Entry.....	153

Locking from Outside

The vehicle can be locked with:

- Remote control key;
- Microswitch;
- Interior boot lid switch;
- NFC key card*.



! REMINDER

- Locking with the mechanical key is an unconventional way to lock. For emergency locking using the mechanical key, refer to the **Emergency - Owner's Emergency - Emergency Unlocking/Locking** section.
- The **Rear Mirror Fold** feature can be activated by tapping on  /  > **Vehicle Settings > Side Mirrors** on the centre console touchscreen. After the function is activated, the side mirrors automatically fold when the vehicle is locked from the outside.
- If the driver attempts to lock the vehicle when any door or the bonnet is not closed, a beep is heard, the turning lights do not flash and the side mirrors do not fold (if the Auto Mirror Fold function is on), meaning locking has failed.
- Make sure the vehicle has been successfully locked by checking that all windows and the sunroof are closed.

Remote Control Key





When the vehicle is OFF with all doors and bonnet closed, and the remote control key within range.

- Press the  button to lock all doors simultaneously. The turning lights flash once and the side mirrors automatically fold (if the Auto Mirror Fold function is on).
- Press and hold the Lock button to lock the vehicle with all windows rolling up automatically. (To activate the **Long Press Lock Key to Close Windows** function, tap on  /  > **Vehicle Settings > Doors, Windows and Lock** on the centre console touchscreen.)

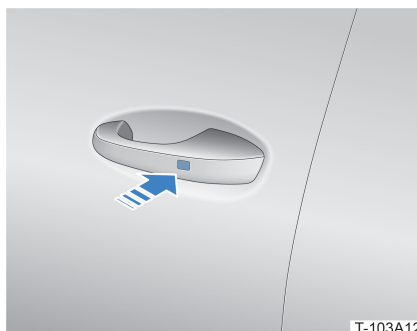
Locking with the Microswitch



The microswitch can be used when the vehicle is off, and all the doors and bonnet are closed. Walk to the front left/right door activation area with the remote key and:

- Press the microswitch on the door handle to lock all doors simultaneously. The turning lights flash once and the side mirrors automatically fold (if the Auto Mirror Fold function is on).
- Press and hold the microswitch to lock the vehicle with all windows automatically rolling up. (To activate the **Long Press Switch to Raise Window** feature, tap on  /  > **Vehicle Settings > Doors, Windows and Lock** on the centre console touchscreen.)

Locking with the Interior Boot Lid Switch

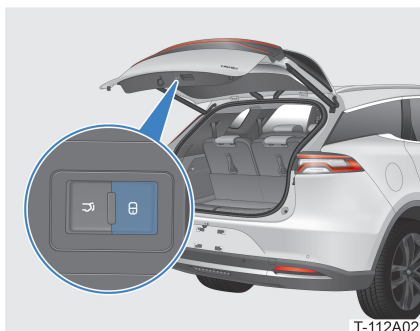

When the vehicle is OFF with the boot opened, but all doors and bonnet closed, walk to the boot carrying the remote control key and press the  button to close the trunk and lock the vehicle. The turning lights flash once, and the side mirrors automatically fold (if the Auto Mirror Fold function is on).

Locking with the NFC Key Card*

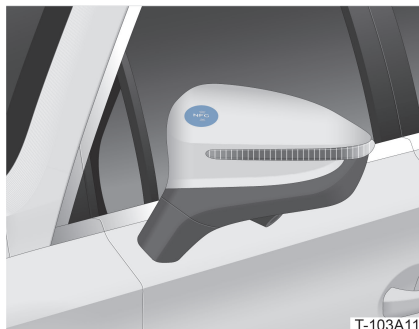

When the vehicle is OFF with all doors and bonnet closed, place the NFC key card on the "NFC" mark on the front left side mirror shell to lock all doors simultaneously. The turning lights flash once, and the side mirrors automatically fold (if the Auto Mirror Fold function is activated).

Anti-Theft Alarm

With the vehicle in anti-theft alarm mode, the horn sounds and the turning lights flash when any door or the boot is opened.

Activating Anti-Theft Alarm

1. Make sure the vehicle is OFF.
2. Have all occupants leave the vehicle.
3. Lock the vehicle. The anti-theft alarm indicator will remain on for 10 seconds until the anti-theft alarm system activates automatically, and its indicator will start flashing.

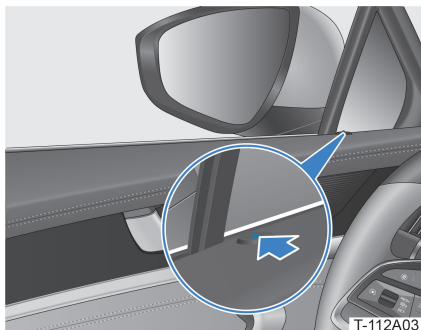

T-112A03

REMINDER

- Walk away from the vehicle as soon as the anti-theft indicator begins flashing

Triggering Anti-Theft Alarm

The anti-theft alarm is triggered when:

- A door, the boot or bonnet is unlocked without using the remote control key or NFC key card*.

Skipping Anti-Theft Alarm

The anti-theft alarm is skipped when:

- The vehicle is unlocked with the remote control key;
- The vehicle is unlocked with the microswitch;
- The vehicle is unlocked with the NFC key card*;
- The boot is opened with the remote control key;
- The vehicle is started with the remote control key.

CAUTION!

- Do not modify the anti-theft alarm system, as this may lead to system failure.

Folding/Unfolding Side Mirrors

Manual Folding/Unfolding

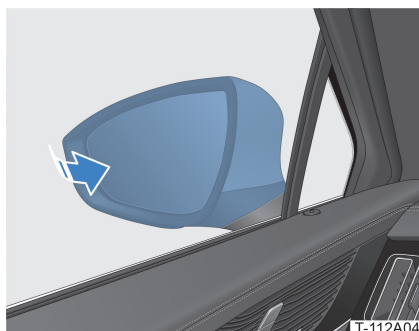

T-112A04

To fold the side mirrors manually, just pull them.

Push in the opposite direction to unfold.



WARNING!

- Be sure to unfold the side mirrors before driving.

CAUTION!

- Do not frequently fold the side mirrors manually. Doing so may damage the internal electric folding mechanism and cause automatic folding to malfunction.

Auto Folding/Unfolding

When the vehicle is powered on, the **Auto Mirror Fold** can be turned on/off by tapping on  /  > **Vehicle Settings** > **Side Mirrors** on the centre console touchscreen:



- The side mirrors automatically fold when the vehicle is locked.
- The side mirrors automatically unfold when the vehicle is unlocked.

Lighting after Exit & before Entry



Headlights after Exit

When this function is activated and appropriate conditions for use are met, the headlights remain lit for a preset period of time after the vehicle is locked.

Operation method

1. When the vehicle is powered on, tap on  /  > **Vehicle Settings** > **Lights & Ambient** on the centre console touchscreen to turn on the **Headlights after Exit** and set the time for the lights to remain on.





2. Turn the end knob of the light stalk switch to the  ,  or  position.
3. When the vehicle is OFF and locked, the headlights remain lit for the preset duration if the outside lighting is dim.



Headlights before Entry

When this function is activated and appropriate conditions for use are met, the headlights remain lit automatically for a set period of time.

Operation method

1. When the vehicle is powered on, tap on  /  > **Vehicle Settings** > **Lights & Ambient** on the centre console touchscreen to turn on the **Headlights before Enter** and set the time for the lights to remain on.



2. Turn the end knob of the light lever switch to the  ,  or  position.
3. When the vehicle is OFF and unlocked, the headlights remain lit for the set time if outside lighting is dim.

13

MAINTENANCE

Regular Maintenance.....	156
Cleaning the Vehicle	159
Exterior Maintenance.....	161
Interior Maintenance	162
Battery Maintenance	162
Other Maintenance	166
Refilling Fluids.....	172
Replacing Fuses	175

Regular Maintenance

Maintenance Schedule

Maintenance item	Readings on odometer or number of months, whichever comes first										
	Maintenance time										
	x1,000 (km)	20	40	60	80	100	120	140	160	180	200
Number of months	12	24	36	48	60	72	84	96	108	120	
Check chassis screw tightening											
Check brake pedal and EPB switch	█		█		█		█		█		
Check brake pads and discs											
Check brake system pipeline and hoses	█		█		█		█		█		
Check caliper assembly guide pin											
Check steering wheel and pull rod	█		█		█		█		█		
Check drive shaft dust cover	█		█		█		█		█		
Check ball pin and dust cover	█		█		█		█		█		
Check front and rear suspensions	█		█		█		█		█		
Check tyre and pressure (including TPMS)											
Check front and rear wheel alignment	█		█		█		█		█		
Rotate tyres	R		R		R		R		R		
Check wheel bearings for clearance	█		█		█		█		█		
Check coolant level in battery and motor coolant auxiliary tank											
Replace drive motor coolant	Replace every 4 years or 100,000km, whichever comes first										
Check brake fluid											
Replace brake fluid	Replace every 2 years or 40,000km, whichever comes first										

Maintenance item	Maintenance time	Readings on odometer or number of months, whichever comes first										
		x1,000 (km)	20	40	60	80	100	120	140	160	180	200
		Number of months	12	24	36	48	60	72	84	96	108	120
Check vehicle module DTC (clear after recording)												
Check torques of high-voltage battery tray, guard plate, bumper bar and installation points												
Replace reducer gear oil.		Replace for the first time after 24 months or 40,000km, whichever comes first. Then replace every subsequent 24 months or 48,000km, whichever comes first										
Check for powertrain leaks or bumps												
Check for loose HV harness or connectors												
Check for deformation or oil marks in HV module cosmetic parts												
Check each charging connector for any foreign objects or burn marks												
Replace high-voltage battery coolant		Replace for the first time after 2 years or 40,000km, whichever comes first. Then replace every subsequent 2 years or 100,000km, whichever comes first										
Check activated carbon high-efficiency filter												
Check PM2.5 quick tester filter screen												
Check that bulbs and LEDs are lighting properly												
Check that headlight dimming function is normal												
Check for any foreign objects or ablation marks at the EPS bonding point												
Check whether EPS connector is loose or connector pins are ablated.												
Check EPS ECU for corrosion												

Maintenance item	Maintenance time	Readings on odometer or number of months, whichever comes first										
		x1,000 (km)	20	40	60	80	100	120	140	160	180	200
		Number of months	12	24	36	48	60	72	84	96	108	120
Check for vehicle module software updates												
Check for water seepage marks on HV parts												
Check torque of wiper arm lock nut												

Designation of table marks:

I: Check, adjust or replace if necessary.

! : Maintenance items need to be added for major service conditions.

R: Replace.

For major service conditions, maintenance items need to be added according to the maintenance schedule. Major service conditions refer to:

- Frequent exposure to dust and salty air.
- Frequent driving on bumpy, uneven, wet or mountainous roads.
- Driving in extreme temperatures (below freezing point or above 35° C) for extended periods.
- Frequent use of brakes and emergency braking.
- Frequent towing of trailers.
- Vehicles used for commercial purposes.

! REMINDER

- Maintenance items, time or frequency are formulated on the assumption that the vehicle is used as a regular means of transportation to carry passengers and goods, without exceeding its load limit.
- In order to ensure the vehicle runs in optimal conditions and that the likelihood of any faults is reduced, it is recommended that maintenance is carried out according to its schedule.

Cleaning the Vehicle

Exterior Cleaning

Be sure normal methods are used to wash the vehicle.

Peeling of paint layers or corrosion of body or other parts can occur quite easily if the vehicle is not washed timely after driving in the following conditions:

- Along the seaside;
- On a road surfaces with antifreeze agents;
- On road surfaces with coal tar, resin or insect carcasses;
- In an areas with heavy smoke, coal ash, dust, iron filings or chemicals;
- When the vehicle is excessively dirty, dusty or muddy.

Washing the Vehicle Manually

Wait for the vehicle to cool down sufficiently in the shade before washing it.

1. Rinse all loose dirt, mud, salt or alkali off the bottom and the wheel cavities.
2. Clean the vehicle with a neutral washing agent, mixed according to the manufacturer's instructions. Gently wipe the vehicle from top to bottom along the direction of the water flow with a soft cloth dipped in cleaning solution. Do not wipe horizontally or in a circular motion.
3. Clean the tyres with special sponges and brushes.
4. Rinse thoroughly.
5. Wipe water marks with an absorbent cloth. Do not use excessive force when wiping to avoid damage to the paint surface.
6. Use an air blower to dry any accumulated water in the vehicle's crevices such as door sealing strips,

side mirrors, charging port covers and headlights.

WARNING!

- Avoid hand injury when cleaning the floor or chassis.

CAUTION!

- Do not use alkaline washing powder, soapy water, detergents, de-waxing detergents or any volatile substance (gasoline, kerosene, or solvent) to clean the vehicle.
- When cleaning the combination lamps, do not wipe their surface with chemical solvents such as gasoline or alcohol. Doing so will cause the combination lamp casings to crack.
- It is recommended that vehicles travelling in coastal or heavily polluted areas be washed more frequently.
- Do not use blades or gasoline to remove hard dirt from the vehicle body. Plastic decorative parts are easily damaged by chemicals or abrasion. If any chemicals are splashed on the decorative parts, clean them immediately with agents meant to clean decorative parts, and check whether they have been damaged. If they have, replace them as soon as possible.
- Do not use abrasive cleaning agents to scrub the bumper.
- When using high-pressure water to clean the vehicle chassis, keep the water pressure at a medium to low level, and keep away from any connectors.
- To clean polished metal parts, a carbon cleaning agent should be used and the parts should be waxed regularly for protection.



SUSTAINABILITY

- The vehicle should be cleaned at certified car wash locations, so as to prevent dumping of harmful chemicals into the environment.

Washing the Vehicle Automatically

Some types of brushes, unfiltered water or procedures in mechanized washing stations may scratch or damage the paint and reduce its durability and sheen.

Consult the washing station staff before washing the vehicle, so as to choose the safest washing procedure.

Interior Cleaning

Please heed the following when cleaning the vehicle interior.



WARNING!

- Do not dampen the airbag components for risk of airbag malfunction or failure, resulting in serious or even life-threatening injury.
- Do not use any polishing substance to clean the dashboard panel. Otherwise, the dashboard panel may reflect on the windscreen and hinder the driver's field of vision.



CAUTION!

- Do not splash any liquid onto any interior surface, for that poses a risk of malfunction to electrical components. Should accidental splashing occurs, wipe it off immediately.
- If detergents need to be used, read its instructions carefully and follow them closely. Avoid using chemicals like kerosene, alcohol, gasoline, etc. or acid-base solutions which may cause discoloration, contamination or peeling of the interior trimming surfaces.

Cleaning the Dashboard Panel and Other Interior Trimmings

When cleaning the dashboard panel, wipe it gently with a damp clean soft cloth.

Do not use blades or other sharp objects to remove dirt from the interior trimming surfaces.

Do not use bristle brushes to clean interior trimming surfaces.

Do not wipe with excessive force, as this may damage the interior trimmings.

Mild neutral detergents should be used whenever possible, and strong detergents or degreasing soap should be avoided.

Do not get the interior trimmings wet when cleaning.

Cleaning Leather

If vehicle leather surfaces are maintained or cleaned for an extended period of time, they may get damp, moldy, dull, dry, aged, etc. Therefore, they must be meticulously maintained and used carefully.

Wipe off any dust on leather surfaces with a damp soft cloth. If more thorough cleaning is needed, professional leather cleaning

products can be used. After cleaning, the leather can be wiped dry or allowed to dry on its own.

Do not use ordinary detergents (such as washing powder and cleansers) to clean leather, as this may damage its surface and cause corrosion or discoloration.

Cleaning Buttons and Switches

Use a small soft brush to clean buttons and switches.

Cleaning Windows

When cleaning glass, use a soft cloth and special glass cleaner. Never use anything abrasive to clean glass. Pay special attention to the rear windscreen heating wire grid.

Cleaning Seat Belts

When cleaning seat belts, use a sponge or soft cloth dipped in neutral soap water or warm water. Check the seat belt regularly for excessive wear or scratches.



CAUTION!

- Wait until the seat belt is completely dry before retracting it, otherwise the retractor may be damaged.

Cleaning Carpets

Clean carpets with a high-quality foam cleaner.

Remove dust with a vacuum cleaner, and scrub the carpet in circular motions with a sponge or brush soaked in foam cleaner.

Do not use water to avoid corrosion of the vehicle body, and keep the carpet as dry as possible.

Exterior Maintenance

Waxing the Vehicle

To keep the paint shiny, it is recommended that the vehicle body is polished and waxed regularly.

Waxing is recommended when the vehicle body paint is no longer water repellent.

The vehicle must be thoroughly cleaned and dried before waxing.

When the paint is exposed to extensive contact with water and droplets do not form but instead remain on the surface, the vehicle body should be waxed again.

Paint Maintenance

Attention should be paid to the following when maintaining good paint conditions:

- Rinse the vehicle as soon as possible after it rains. Stains may gradually appear on the paint due to the concentration of acidic substances in rain water.
- When washing the vehicle, use specialized cleaning products instead of washing powder, soaps or detergents with high alkalinity that are used for other purposes, so as to prevent the removal of grease that is necessary to maintaining optimal paint conditions, and the premature aging of the paint.
- When taking the vehicle to a washing station, make sure the staff will not use de-waxing detergent.
- Use a clean and soft cloth or sponge to clean the vehicle, and make sure there are no abrasive grains on them. To avoid scratches, do not use a dry cloth, dry towel or dry sponge to clean the vehicle. Wipe gently from top to bottom along the direction of water flow, and do not

wipe the vehicle horizontally or in a circular motion.

- Quickly remove any major or highly corrosive blemishes (such as asphalt and bird droppings) and clean them using special detergents. Do not use blades or gasoline to remove them, as they will damage the paint surface.
- Do not touch the paint with greasy hands or scrub it with a greasy cloth. Do not place tools or cloth contaminated with chemicals on the vehicle body to avoid adverse reactions.
- If there is no obvious scratching on the paint, do not repaint, to prevent the paint colour from being inconsistent or blending poorly.
- Avoid strong impacts, bumping or scratching the paint film. If the paint surface is found to be scarred, dented or peeling off, contact a BYD authorised dealer or service provider as soon as possible for repair.
- Clean plated metal parts with carbon cleaner and wax them regularly for protection.
- Use quality detergent to clean the body. Do not wipe too hard when waxing to avoid damage to the paint surface.
- Wax the paint occasionally, and contact a BYD authorised dealer or service provider for regular maintenance (once every three months), so as to restore paint sheen.

Interior Maintenance

Interior maintenance should follow interior cleaning. After interior cleaning is completed, interior maintenance can be carried out as follows:

- After the dashboard panel is cleaned, a

layer of protective wax should be applied in order to slow down its aging and that of other plastic parts, and to prolong their service life.

- Leather surfaces can be sprayed with special leather wax, and then wiped with a dry cloth.
- Glasses can be sprayed with glass coating products to prevent fogging in rainy and snowy weather, or during winter.
- Regularly maintain the door sealing strips with a rubber maintenance agent to keep them supple and in good conditions.

Battery Maintenance

Maintaining the 12V Battery (Starter Fe Battery)

Checking the Battery

Regularly check the surface of the 12V battery (starter Fe battery) and the anode and cathode terminals to ensure they are not loose or rusted.

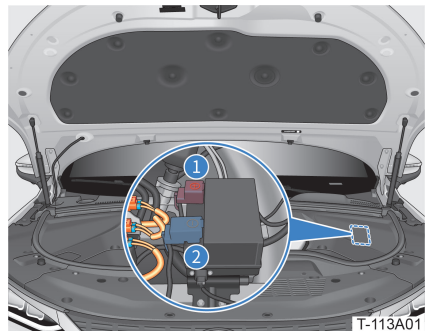

- 1 Anode
- 2 Cathode

Check the appearance of the 12V battery (starter Fe battery) for cracks and swelling. If any abnormality is found, contact a BYD authorised dealer or service provider.

Replacing the 12V battery (starter Fe battery)

The 12V battery (starter Fe battery) must be replaced with another of the same model and specification. It is recommended that a BYD authorised dealer or service provider is contacted to replace it.



SUSTAINABILITY

- Please recycle the 12V battery (starter Fe battery) in accordance with local regulations.

Precautions for 12V battery (starter Fe battery) Use and Maintenance

Please read and observe the following precautions when using and maintaining the 12V battery (starter Fe battery).



WARNING!

- When removing the 12V battery (starter Fe battery) terminals, make sure to remove the cathode terminal first. If the anode terminal makes contact with any metal in the surrounding area during removal, there may be sparks and even fire, as well as a high risk of electric shock, resulting in serious or even life threatening injury.



WARNING!

- Turn off all electrical equipment on the vehicle before turning on the 12V battery (starter Fe battery) again. First connect the anode terminal and then the cathode. Do not install the 12V battery (starter Fe battery) in the wrong order, as this may cause fire.
- The 12V battery (starter Fe battery) should be kept away from heat sources and open flames, and it should be well-ventilated when charged and used. Failure to do so may result in fire or personal injury.
- Regularly check whether the fixing clips of the 12V battery (starter Fe battery) terminal are firm and in good contact.
- The 12V battery (starter Fe battery) has a built-in power manager. Do not disassemble or repair the 12V battery (starter Fe battery) without authorisation, so as to avoid damage or personal injury.



CAUTION!

- Avoid Fe battery overcharging or long-term power loss.
- Avoid long-term heavy-current discharge of the 12V battery (starter Fe battery).
- The 12V battery (starter Fe battery) should be firmly installed on the vehicle to avoid vibration.
- Oxides and sulfates generated by fixing clips of 12V battery (starter Fe battery) terminals must be cleaned quickly, and grease should be applied to avoid corrosion recurrence.
- Starter Fe batteries need to be charged with professional tools. Do not take them out or charge them without authorisation.



CAUTION!

- 12V battery (starter Fe battery) can be used normally only after communicating with the vehicle. Make sure to connect and harness it correctly.
- When cleaning the 12V battery (starter Fe battery), make sure to prevent any liquid from entering.



REMINDER

- The 12V battery (starter Fe battery) has a built-in relay, and it is normal for the relay to pull in when starting the vehicle.

High-Voltage Battery Maintenance

The high-voltage battery is the power source of the vehicle and can be recharged repeatedly.

- The high-voltage battery can be charged through an external power source.
- When the vehicle is braking or coasting, the high-voltage battery can also be charged by means of regenerative braking.

The high-voltage battery is located under the vehicle's floor. When driving, make sure to avoid impact on or flooding of the high-voltage battery.

As the battery is affected in its electrochemical characteristics, to protect it, it is normal for the vehicle to have certain differences in performance under the following conditions:

- The vehicle's regenerative braking performance is weakened when the high-voltage battery SOC is high and enhanced when the SOC is reduced. In this period, there is a stage of transition to enhanced regenerative braking performance.
- When the high-voltage battery SOC is high, it will switch to trickle charging mode, and the terminal charging time will be lengthened. The estimated remaining charging time displayed on the instrument cluster will also have a deviation.
- When the high-voltage battery SOC is low, the vehicle's acceleration performance is weakened.
- It is normal for the charging capacity of the high-voltage battery to be weakened and for charging time to be prolonged at high or low temperatures. When this occurs, it is recommended that high-power charging equipment is used for quick charging. Driving in extreme temperatures may weaken power performance.
- At low temperatures, available high-voltage battery SOC will decrease along with the decrease in temperature.

Under normal high-voltage battery conditions, driving range is affected by the following factors:

- Driving habits: good driving habits can prolong driving range.
- Road conditions: driving in bad road conditions will shorten driving range.
- Temperature: driving in low temperatures will shorten driving range.
- Usage of electrical equipment: if A/C is on while driving, driving range will be shortened.
- The available SOC will decrease along with the increase in the vehicle's service time.

WARNING!

- It is strictly forbidden to disassemble or modify the high-voltage battery, or use it for other purposes.
- Make sure that the high-voltage battery is kept away from fire sources to avoid fire or explosion.
- Do not spray, trample, impact or damage the high-voltage battery to avoid leakage, fire or explosion of corrosive chemicals.
- It is strictly forbidden to touch either the anode or cathode terminals of the high-voltage battery box with bare hands.
- It is strictly forbidden to crush, pierce or burn the high-voltage battery.
- If the high-voltage battery is seriously damaged mechanically, and the internal HV components are exposed, there will be serious danger of major combustion or electric shock, which may lead to serious personal injury and environmental pollution.
- Leakage of electrolyte from the high-voltage battery may cause a fire.
- If the electrolyte in the high-voltage battery comes into contact with skin or eyes, immediately wash the affected area with abundant water and seek medical advice at once.

Recycling the High-Voltage Battery

When the vehicle is ready to be scrapped, recycle the high-voltage battery in accordance with local regulations.

Using the High-Voltage Battery

It is recommended that the vehicle is used in temperatures between -10~40° C, and the battery is timely charged in case of low

SOC to ensure adequate driving range and optimum acceleration performance.

Avoid exposing the vehicle to temperatures above 40° C or below -30° C for over 24 hours in succession.

If the vehicle needs to be parked for a long period of time in relatively low ambient temperatures, search for areas with relatively higher temperatures such as heated garages or warmer underground garages.

While driving, avoid frequent, sudden acceleration and deceleration, and drive on level and dry roads. If necessary, turn off high-power electric equipment such as A/C system, or adjust its temperature to reduce power consumption to extend driving range.

As the SOC displayed on the instrument cluster may deviate from the actual value, it is recommended that the vehicle is fully charged if used for the first time or used again after being parked for an extended period of time.

To keep the high-voltage battery at its best, charge it fully on a regular basis (at least once a week).

Under extreme driving conditions (such as sudden and continuous acceleration or deceleration), if the high-voltage battery temperature is too high, its discharge capacity will gradually decrease, which is normal. If the battery temperature continues to rise, the warning light for high battery temperatures on the instrument cluster will light up . In this case, please contact a BYD authorised dealer or service provider.

When the high-voltage battery SOC rises or drops abnormally, please contact a BYD authorised dealer or service provider.

As the high-voltage battery slowly heats up, the temperature control system will not display too obvious effects for a short period of driving, which will increase power consumption and shorten driving range.

After driving for a longer period, the battery temperature will rise naturally, making it less necessary for heating to take place. To better improve driving experience, the battery temperature control system is mainly used to guarantee low-temperature charging performance.

In case of emergency, observe the following precautions:

WARNING!

- Do not make direct contact with the high-voltage battery to avoid personal injury.
- Contact a BYD authorised dealer or service provider as soon as possible.
- If the high-voltage battery is damaged and there is fluid leakage, avoid direct contact with such fluids. If the fluids come into contact with skin or eyes, wash the affected area with plenty of water and seek medical help immediately.
- If the vehicle catches fire, extinguish the fire with plenty of water and do not use water-based extinguishers.

CAUTION!

- To ensure the high-voltage battery safety, the vehicle must be kept away from inflammables, explosives, heat sources and any dangerous chemicals when parked.
- The vehicle must be parked away from heat sources, and avoid long exposure to sunlight, so as to extend high-voltage battery service life.
- Users are forbidden to refill battery coolant by themselves. This should be done by BYD authorised dealers or service providers only.

Other Maintenance

Tyre Maintenance

To ensure safety, tyre type and size must follow vehicle specifications. Tyre treads and pressure must always be kept in check.

Tyre Pressure

Tyre pressure values for applicable vehicles can be found on the left B pillar sticker.

The instrument cluster can be used to check whether the current tyre pressure values are normal. Please refer to **Driving-Safety Assist-Tyre Pressure Monitoring**.

WARNING!

- Insufficient tyre pressure will aggravate its deflection. Overheating may cause tyres to burst. Excessively high or low tyre pressure will accelerate tyre wear, reduce vehicle stability, and increase the risk of traffic accidents.

REMINDER

- When checking tyre pressure, the tyre must not be warm. Tyre pressure will rise along with the temperature, making it slightly above the specified pressure. In this case, it is not necessary to depressurise.
- Balance passenger and luggage weight, avoid ramps or slopes, and adjust the pressure according to vehicle load.
- Make sure to replace the valve cap after checking tyre pressure.

Concealed Damage

Damage in tyres and rims is often concealed. Abnormal vehicle vibration or straying when driving indicates that tyres may be damaged. If tyres are suspected to be damaged, reduce speed immediately and stop to check for any damage. If no damage is found, contact a BYD authorised dealer or service provider for an inspection as soon as possible.

Precautions for Wheel Failure

When driving over a kerb or similar obstacle, the tyre angle should be as right as possible and speed as low as possible.

Regularly check tyre damage (e.g., breakage, wear, deformation, bulging, etc.).

Regularly remove any debris embedded in tread grooves.

New Tyres and Wheels

Size, load range, rated speed and structure of new tyres should be the same as those of the original ones.

Try not to replace only one tyre, but at least two on the same axle at the same time. Do not mix tyres of different sizes or types, and do not mix summer tyres, winter tyres or all-season tyres.

Winter Tyres and Summer Tyres

Winter Tyres

Winter tyres have good grip performance on snow-covered roads. The special rubber tread design makes the tyre less affected by low temperature environments, and provides excellent braking ability, thus improving driving safety.

It is recommended that winter tyres are used when the temperatures are below 7° C or when the vehicle runs on snowy and icy roads.

Use radial winter tyres which are licensed for this vehicle and have the same size, load and rated speed as those of the original ones.

The winter tyre tread should be sufficiently deep (tread depth should not be below 4mm, otherwise the applicability in winter will be limited).

Check tyre pressure after installing.

Summer Tyres

The summer season is generally rainier, so tyre tread depth directly affects driving safety. There is a high risk of hydroplaning when the tread depth of summer tyres is below 3mm.

Recommendations for Use

Winter and summer tyres are designed for specific driving conditions in their corresponding seasons. It is recommended that winter and summer tyres are used in their respective seasons. Doing otherwise may result in poor adhesion and braking ability.

If summer tyres are used under major cold weather conditions, cracks may appear, resulting in tyre damage, increased tyre noise and loss of balance.

Traction may decrease, road noise may increase and tread life may shorten on dry roads. After changing to winter tyres, beware of the changes in vehicle control and braking.

The maximum speed of winter tyres is relatively low, so do not exceed maximum speed.

When the temperature rises above 7° C, tyres should be quickly replaced with summer tyres or all-season tyres to ensure driving safety and performance.

Tyre Service Life

Tyre service life depends on pressure, driving habits and assembly conditions.

Checking for Tyre Wear

Wear marks are cast inside tyre treads.

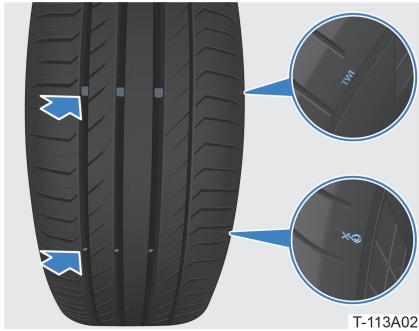

∞ : Wearing to this position indicates that the tyres have poor anti-skidding capabilities.

TWI: Wearing to this position indicates that the tyres need to be replaced.

Tyre Rotation

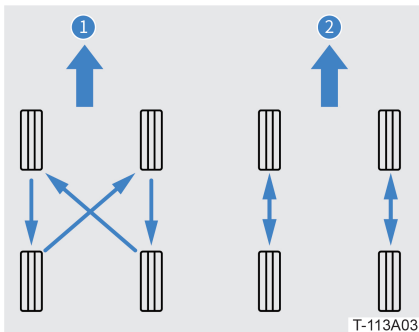

1 Non-directional tyre rotation.

2 Directional tyre rotation.

To avoid uneven tyre wear and extend service life, rotate tyres according to the maintenance schedule. After tyre rotation, get familiar with the four-wheel alignment and tyre pressure monitoring system, and adjust the tyre pressure to the specified range (refer to **Vehicle Information-**

Technical Parameters-Wheel and Tyre Parameters).

Wheel Balance

The wheels of any new vehicle have been dynamically balanced, but they may become unbalanced with driving due to various influences.

Unbalanced wheels will aggravate the wear and impact on steering system and tyres, so they must be dynamically balanced again.

Every wheel must be dynamically balanced again after tyres are repaired or new tyres are installed.

Wheel Alignment

Misalignment of wheels will lead to uneven and excessive wear of tyres, which will affect driving safety. In the event of uneven and excessive tyre wear, contact a BYD authorised dealer or service provider to check alignment as soon as possible. Four-wheel alignment is required in the following situations:

- Driving performance is abnormal, such as deviation;
- Suspension system components have been removed or replaced;
- Tyres on one side are worn.

Self-learning

After tyre replacement or rotation, contact a BYD authorised dealer or service provider to update data with the diagnostic device.

Precautions for Tyre Use

Read and observe the following precautions when using and maintaining tyres.

WARNING!

- For the first 500km, new tyres may not optimally adhere to the road, so drivers should drive carefully at moderate speed to avoid accidents.
- Burst or leaking tyres can easily cause serious traffic accidents.
- Do not use tyres over 6 years old.
- Under no circumstances, should old wheels and tyres of unknown origin be used. Doing so may cause the driver to lose control of the vehicle and result in traffic accidents.

CAUTION!

- Do not expose tyres to chemicals, oil, grease or brake fluid.
- In the event of abnormal vehicle vibration or deviation while driving, stop immediately and check whether the tyres are damaged.
- Insufficient road adhesion of tyres that have not been run-in or are excessively worn will directly affect braking performance. If uneven and excessive tyre wear is found, contact a BYD authorised dealer or service provider as soon as possible.

Sunroof Maintenance

- Wipe any dust or sand from the sunroof outer sealing strip with a wet cloth and do not scratch it in the process, for that will degrade its sealing performance.
- Wipe any dust or sand on the injection molding edge of the sunroof with a wet cloth and do not scratch the sealing strip, for that will degrade its sealing performance.

- Clean the front end of the sunroof frequently to remove dust, sand, leaves and other debris. This will prevent the drain hole from being blocked and maintain proper drainage.
- Clean the guide rails on both sides and the front flume frequently to prevent dust, sand, leaves and other debris to prevent drain hole blockage.
- When washing the vehicle, avoid aiming any high-pressure water guns directly at the sealing strip. This will not only deform or damage the sealing strip, but can also result in water seeping into the vehicle.
- In winter, the sunroof can easily freeze, and if it is opened under such conditions, the sealing strip or other parts of the sunroof will be damaged. The vehicle should first be preheated, and the HVAC system should be turned on to speed up the melting of snow and ice. Open the sunroof only after the vehicle has reached a certain temperature.
- Do not fully open the sunroof on extremely bumpy roads, as the strong vibration may cause deformation of related components and potentially damage the motor. In addition, the sunroof is not to be opened when it is raining or when the vehicle is being cleaned.

A/C System Maintenance

The A/C is a closed system, and any important maintenance work should be carried out by professionals from a BYD authorised dealer or service provider.

The following can be done to ensure effective operation of the A/C system:

CAUTION!

- Whenever the A/C system is overhauled, the maintenance station should be required to ensure the use of refrigerant recycling equipment.
- Check the radiator and A/C condenser regularly. Remove leaves, insects and dust accumulated on the surface. These deposits will hinder the air flow and reduce the cooling effect.
- If the cooling effect of the A/C system is not optimal, contact a BYD authorised dealer or service provider.

REMINDER

- In cold months, it is recommended that the A/C is turned on once a week for at least 10 minutes to circulate the fluid in the refrigerant unit.



SUSTAINABILITY

- Recycle the refrigerant in accordance with local regulations.

Replacing Wiper Blades

Check the condition of the front and rear wiper blades at least once every six months to see if there are cracks, hardening, etc. If any of these are found, the wiper blades should be replaced. Failure to do so will result in streaks or scratches over use.

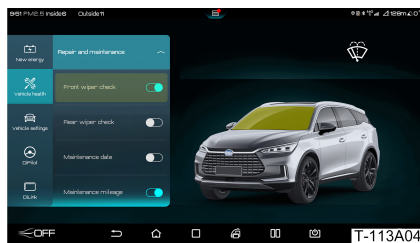

Replacing Front Wiper Blade

1. Power on vehicle.
2. Tap on  /  > **Vehicle Health > Repair and Maintenance** on the centre console touchscreen to activate the **Front Wiper Check** feature. The front wiper will automatically enter repair position.





3. Lift the wiper arm.
4. Press the wiper blade locking button (1), hold the wiper blade buckle, and pull out the wiper blade (2).



5. Follow the same procedure in reverse to insert the new wiper blade into the wiper arm and lock it in place.
6. Gently lay the wiper arm onto the front windshield.
7. Tap on  /  > **Vehicle Health > Repair and Maintenance** on the centre console touchscreen to deactivate the **Front Wiper Check** feature. The front wiper automatically run to the initial position.

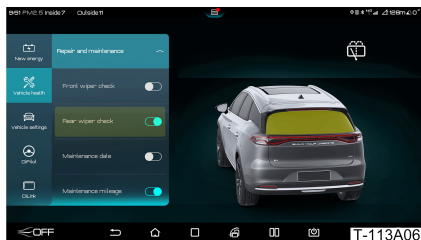

Replacing Rear Wiper Blade

1. Power on vehicle.
2. Tap on  /  > **Vehicle Health>Repair and Maintenance** on the centre console touchscreen to activate the **Rear Wiper Check** feature. The rear wiper will automatically enter repair position.

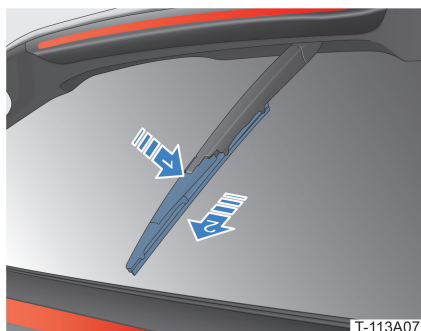

3. Lift the wiper arm.
4. Lift the wiper arm slightly, press the wiper blade (1), and remove wiper blade (2).



5. Follow the same procedure in reverse to install the new wiper blade, and gently lay the wiper arm onto the rear windscreen.
6. Tap on  /  > **Vehicle Health>Repair and Maintenance** on the centre console touchscreen to deactivate the **Rear Wiper Check** feature. The rear wiper automatically runs to the initial position.

CAUTION!

- After lifting the wiper arm, cover the windscreen with something soft, such as a towel, to avoid damage to the windscreen in case the wiper arm suddenly falls.
- Do not bend the wiper blade.

Anti-Corrosion Measures

This vehicle has effective anti-corrosion protection. However, in order to reduce the risk of corrosion, the following measures should be taken:

- Wash the vehicle frequently. Regular washing can keep it clean and prevent corrosion.
 - » If the vehicle runs on roads with saline or alkali substances in winter, or if the user lives by the sea, it is recommended that the vehicle is carefully cleaned once a month to reduce corrosion.
 - » Avoid connectors and electrical parts when cleaning the vehicle chassis and wheel casing with a high-pressure water.
 - » After winter, make sure not to leave cleaning chemicals such as snow melting agents on the vehicle chassis.
- Check the body paint and decorative parts.
 - » If any fragments or cracks are found on the paint, contact a BYD authorised dealer or service provider for repair to prevent corrosion.
- Keep the vehicle interior dry.
 - » Moisture and dust easily accumulate under the carpet. Frequent checking under the carpet is necessary to ensure the area remains dry, clean and corrosion free.

- » Goods like chemicals, detergents, fertilizers, salt, etc. must be placed in proper containers. If spills or leaks are found, the containers should be cleaned immediately and kept dry.
- Try to park the vehicle in a fully ventilated garage or a sheltered location. Avoid parking in damp, non-ventilated places.
- It is recommended that the integrity of the bottom wax layer is checked regularly. In case of any damage, the damaged area should be re-waxed to prevent corrosion.
- The dismantled fasteners should also be waxed in vehicle maintenance.
- When applying wax, avoid the high-voltage wiring harnesses, rubber bushings, wiring harness connectors and high-voltage battery cable ports.

Long-Term Parking

If the vehicle needs to be parked for an extended period of time (over one month), the following preparations should be heeded:

- Before parking, make sure the high-voltage battery SOC is between 25% and 40%.
- It is recommended that maintenance is carried out once a month. The high-voltage battery should first be fully charged through AC trickle charging, and then discharged to 25%-40% before parking.
- Park the vehicle in a dry, well ventilated environment, and away from heat sources.
- Clean and dry the vehicle body thoroughly.
- Clean the interior of the vehicle to ensure that the carpet and interior trimmings are completely dry.

- Open the window on one side slightly (when parking indoors).
- Disconnect the cathode (-) of the 12V battery (starter Fe battery).
- Pad the wiper blade with a towel or cloth so that it does not come into contact with the windscreen.
- Cover the vehicle body with a cover made of porous material such as cotton cloth. Covers of non-porous materials such as plastic can retain moisture and damage the paint.
- If possible, start the vehicle regularly (preferably once a month).
- If the vehicle has been parked for over three months, first confirm whether the instrument cluster gives an alarm before using the vehicle again. If so, contact a BYD authorised dealer or service provider.

Refilling Fluids

Opening and Closing the Bonnet

Opening the Bonnet

1. Pull up the bonnet opening handle twice in succession and it will pop up.

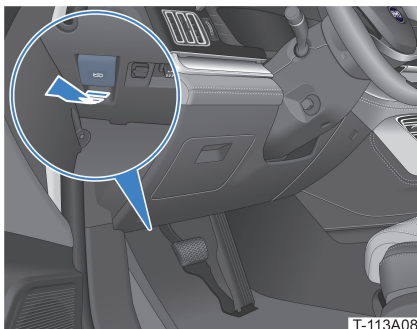

T-113A08

- Lift the bonnet up to a certain degree and let it go. It will automatically open to its maximum extent.

Close the bonnet

Close the bonnet and make it fully locked.

WARNING!

- Do not close or press the bonnet hard; otherwise, the bonnet may be damaged.
- Before driving, please confirm that the bonnet is completely closed.

Refilling Windscreen Washing Liquid

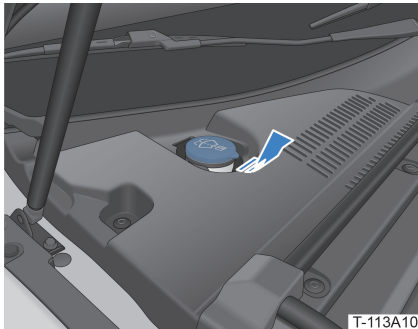

Check the washing liquid. If it is insufficient, refill it (refer to **Vehicle Information-Technical Parameters-Type and Dosage of Vehicle Filling Liquid**).

WARNING!

- Do not add any supplements to the windscreen washing liquid, for they may cause stains or deposit of other substances, negatively affecting visibility.
- If the windscreen washing liquid comes into contact with skin or eyes, immediately wash the affected area with abundant water and seek medical help at once.

CAUTION!

- Do not mix the windscreen washing liquid with other cleaners. Doing so may clog the windscreen washer nozzle.

Checking Coolant

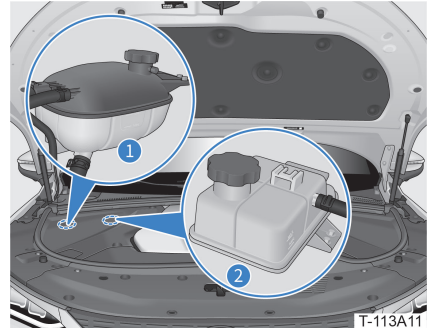

- Auxiliary motor coolant tank.
- Auxiliary battery coolant tank.

- Open the bonnet and remove its right trimming panel.
- When the vehicle has cooled down, check that the coolant level of the auxiliary coolant tank is between the "MAX" (maximum scale line level) and "MIN" (minimum scale line level) marker lines.

3. If the liquid level is below "MIN", add the designated coolant so that the level is between the "MAX" and "MIN" marker lines (refer to the **Vehicle Information -Technical Parameters-Type and Dosage of Vehicle Filling Liquid**).

! WARNING!

- When the vehicle is hot, do not touch the auxiliary coolant tank or remove the filler cap.
- Coolant must be stored in marked containers and kept out of the reach of children.
- If the coolant comes into contact with skin or eyes, immediately wash the affected area with abundant water and seek medical help at once.

! CAUTION!

- The use of any non-designated coolant may damage the cooling system.

! SUSTAINABILITY

- Waste coolant must be disposed of in accordance with local regulations.

Checking Brake Fluid



Checking the brake fluid:

1. Open the bonnet and remove its middle trimming.
2. Check that the brake fluid level is between the "MAX" (maximum scale line level) and "MIN" (minimum scale line level) marker lines.
3. If the liquid level is below "MIN", add the designated brake fluid so that the liquid level is between the "MAX" and "MIN" marker lines (refer to the **Vehicle Information -Technical Parameters-Type and Dosage of Vehicle Filling Liquid**).

! WARNING!

- Brake fluid must be stored in marked containers and kept out of the reach of children.
- If the brake fluid comes into contact with skin or eyes, immediately wash the affected area with abundant water and seek medical help at once.

! CAUTION!

- Do not let brake fluid come into contact with the paint. If it happens, wash it off immediately.
- The use of any non-designated brake fluid may damage the brake system.
- It is recommended that brake fluid is replaced by a BYD authorised dealer or service provider.

! SUSTAINABILITY

- Waste brake fluid must be disposed of in accordance with local regulations.

Replacing Fuses

Checking/Replacing Fuses

If any electrical components in the vehicle do not function, it may be due to a blown fuse. Check the fuse box as soon as possible and replace the fuse if necessary.

WARNING!

- Do not use fuses of different specifications or any other solution other than fuses. Doing so will damage electrical components and potentially cause a fire.

This vehicle is equipped with three fuse boxes: the front compartment fuse box, the dashboard fuse box and the rear compartment fuse box.

Positions of Fuse Boxes

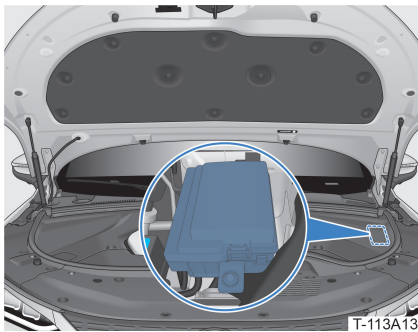

Front compartment fuse box

The front compartment fuse box is located on the left side of the front compartment.

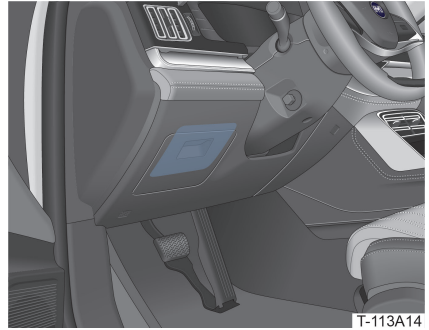

Dashboard fuse box

The dashboard fuse box is located in the guard plate under the dashboard.

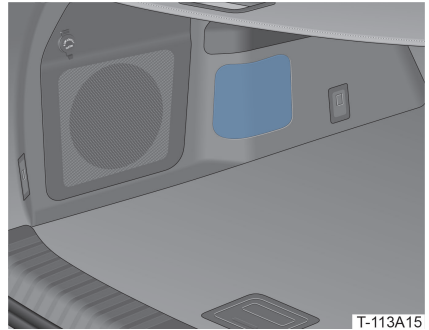

Rear compartment fuse box

The rear compartment fuse box is located in the boot left facing assembly.

Fuse Distribution

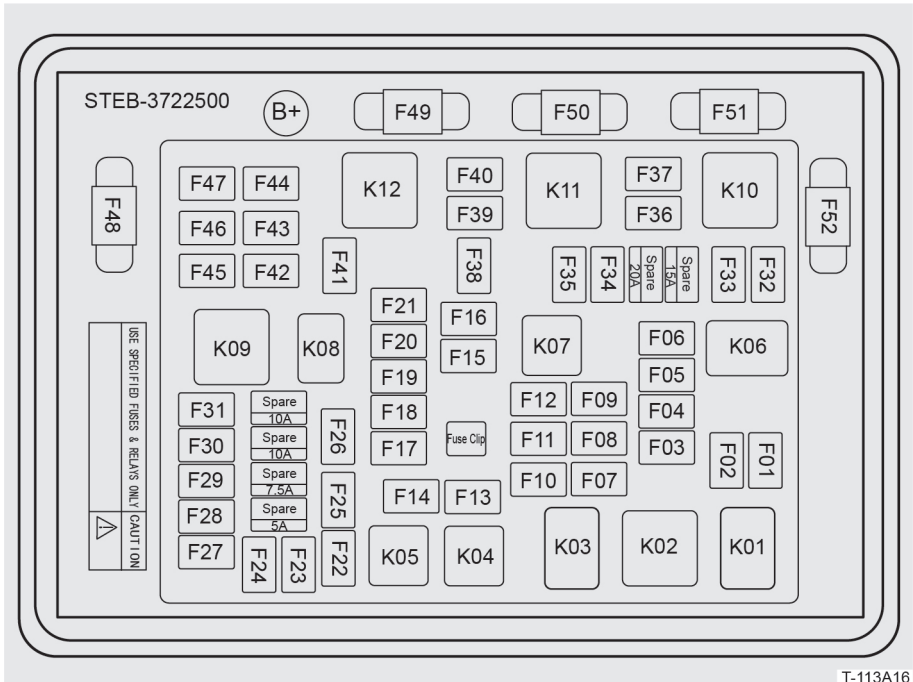

T-113A16

Distribution of Front Compartment Fuse Boxes

S/N	Ampere (A)	Function
F01	-	-
F02	-	-
F03	-	-
F04	-	-
F05	-	-
F06	-	-
F07	10	ABTMP (Adaptive Battery Thermal Management Pump)
F08	10	A/C Module
F09	7.5	BMC (Battery Management Controller)

S/N	Ampere (A)	Function
F10	5	Battery Heater
F11	10	DMC (Drive Motor Controller)
F12	10	DMC Pump
F13	60	IPB (Integrated Power Brake)
F14	40	Blower
F15	-	-
F16	-	-
F17	15	Horn
F18	-	-
F19	-	-
F20	5	CDU (Bi-Directional On-Board Charger and DC-DC and Power Distribution Unit Assembly)
F21	10	FL_R (Front Lamp_Right)
F22	-	-
F23	-	-
F24	-	-
F25	15	WSH (Windscreen Wash Motor)
F26	-	-
F27	-	-
F28	-	-
F29	-	-
F30	-	-
F31	-	-
F32	-	-
F33	-	-

S/N	Ampere (A)	Function
F34	-	-
F35	5	Boost DC
F36	-	-
F37	-	-
F38	10	FL_L (Front Lamp_Left)
F39	60	IPB (Integrated Power Brake)
F40	-	-
F41	20	VTOV (Vehicle to Vehicle)
F42	-	-
F43	25	FR WIP (Front Wiper)
F44	-	-
F45	-	-
F46	-	-
F47	-	-
F48	200	Battery
F49	60	FAN
F50	100	R-EPS (Rack-Electronic Power Steering)
F51	80	IEC (Dashboard area fuse and relay box)
F52	80	TEC (Trunk fuse and relay box)
K01	-	-
K02	-	-
K03	-	IG4
K04	-	-
K05	-	-
K06	-	-

S/N	Ampere (A)	Function
K07	-	IG3
K08	-	VTOV (Vehicle to Vehicle)
K09	-	-
K10	-	-
K11	-	-
K12	-	-

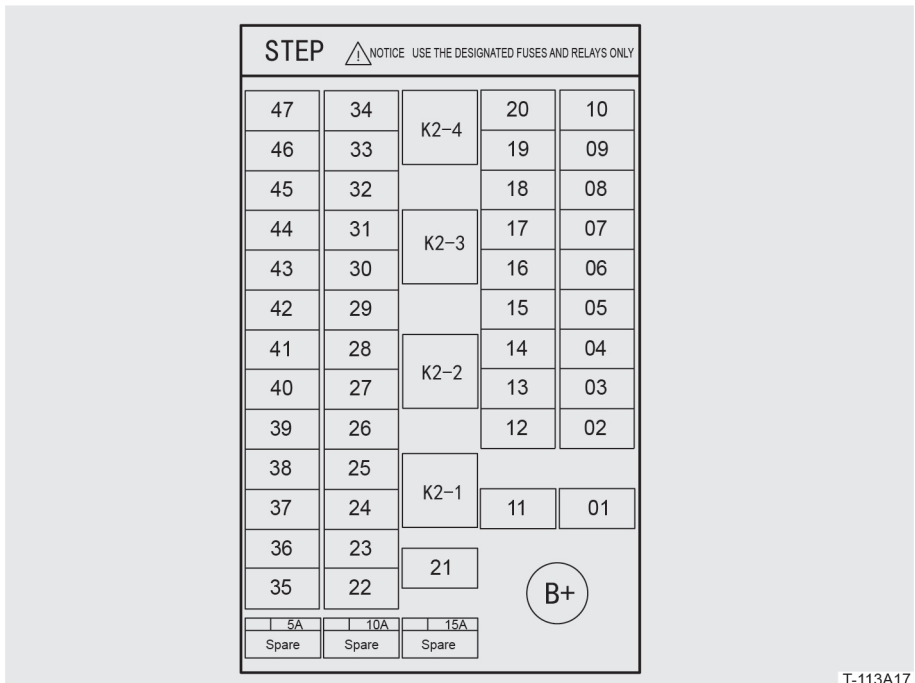

Distribution of Dashboard Fuse Boxes

S/N	Ampere (A)	Function
1	-	-
2	30	BCM (Body Control Module)

S/N	Ampere (A)	Function
3	10	A/C
4	20	Door Lock
5	5	Stop (Brake Light Switch)
6	7.5	Switch BAT
7	10	Door ECU
8	5	Meter (Cluster)
9	20	S/ROOF (Sun Roof Motor)
10	5	NFC
11	-	-
12	10	DLC (Data Link Connector)
13	20	Multimedia
14	-	-
15	-	-
16	15	STR Column (Steering Column)
17	7.5	DOME (Interior Lamp)
18	30	P/SEAT FR (Passenger Seat Front Right)
19	30	P/SEAT FL (Passenger Seat Front Left)
20	20	FL Door (Front Left Door Window Motor)
21	40	PWR Window (Power Window)
22	-	-
23	-	-
24	5	ABS/ESP/IPB
25	5	EPS (Electronic Power Steering)
26	10	SRS (Supplemental Restraint System)
27	15	SW Heater (Steering Wheel Heater)

S/N	Ampere (A)	Function
28	5	Meter IG1 (Cluster IG1)
29	5	ADAS
30	15	P/SEAT ECU (Driver Seat ECU)
31	7.5	Shift
32	20	FR Door (Front Right Door Window Motor)
33	20	RL Door (Rear Left Door Window Motor)
34	20	RR Door (Rear Right Door Window Motor)
35	-	-
36	-	-
37	7.5	Switch IG1
38	5	EPB ECU
39	7.5	PM2.5
40	-	-
41	-	-
42	-	-
43	-	-
44	-	-
45	7.5	USB
46	15	Backup PWR
47	-	-
K2-1	-	IG1 Relay
K2-2	-	ACC Relay
K2-3	-	-
K2-4	-	-

STEB

⚠ NOTICE: USE THE DESIGNATED FUSES AND RELAYS ONLY

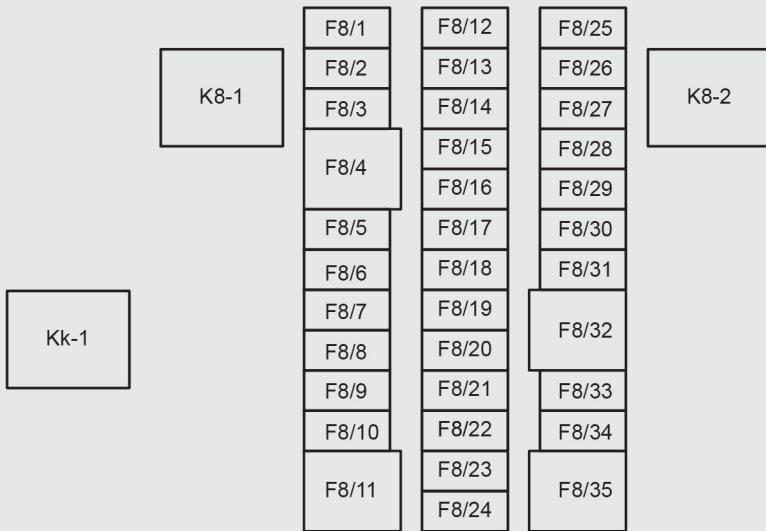

T-113A18

Distribution of Rear Compartment Fuse Boxes

S/N	Ampere (A)	Function
F8/1	-	-
F8/2	-	-
F8/3	7.5	MIR HTR (Exterior Rear View Mirror Heater)
F8/4	40	DEF (Defroster)
F8/5	30	EPB (Electronic Parking Brake)
F8/6	30	EPB (Electronic Parking Brake)
F8/7	20	External amplifier
F8/8	-	-
F8/9	-	-
F8/10	-	-
F8/11	20	BD-ECU (Rear Hatch Controller)

S/N	Ampere (A)	Function
F8/12	10	ECU BAT (+30 for controller)
F8/13	5	I-KEY (Intelligent key)
F8/14	10	Charging Cap Lock
F8/15	5	Charging Lamp
F8/16	10	R-Tail (Rear Clearance Lamp / Charging State Indicator)
F8/17	7.5	RR FOG/B-Lamp (Rear Right Fog lamp / Reversing Lamp)
F8/18	7.5	DC Charging Lamp
F8/19	10	R-HAZ (Rear Hazard Warning Lamp)
F8/20	20	ACC
F8/21	15	Toddler Lock
F8/22	15	Backup PWR (Backup Power)
F8/23	-	-
F8/24	-	-
F8/25	-	-
F8/26	-	-
F8/27	-	-
F8/28	-	-
F8/29	-	-
F8/30	-	-
F8/31	-	-
F8/32	-	-
F8/33	-	-
F8/34	15	RR WIP (Rear Wiper)
F8/35	30	R-Blower (Rear Blower)
Kk-1	-	RR WIP Relay (Rear Wiper Relay)
K8-1	-	DEF Relay (Defroster Relay)
K8-2	-	Reserve Relay

14

EMERGENCY

Owner's Emergency.....	186
Rescue	196

Owner's Emergency

Unlocking/Locking

If the central locking system, remote control key or NFC key card* fails, the mechanical key can be used to lock/unlock the door in the event of an emergency.

Unlocking/Locking Front Left Door

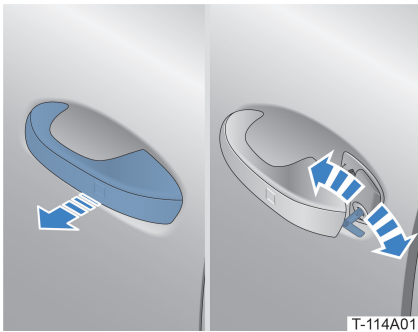

Pull the front left door handle as far as it can go, insert the mechanical key into the keyhole, turn it, and pull out the key.

Unlocking: Turn the mechanical key clockwise.

Locking: Turn the mechanical key counterclockwise.

If you still need to open the front left door after unlocking it, pull the handle again.

CAUTION!

- After using the mechanical key, put it back into the remote control key as soon as possible.
- Unlocking the door with the mechanical key in anti-theft alarm mode will trigger the alarm.

Unlocking/Locking Other Doors

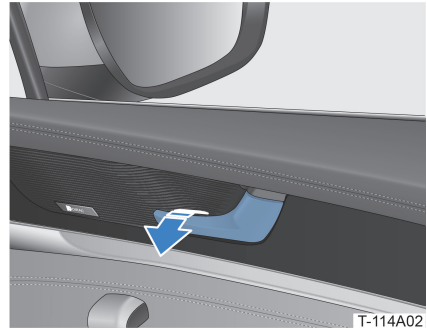

Unlocking:

1. Unlock the front left door and enter the vehicle.
2. Pull the interior handle to unlock the corresponding door, and pull it again to open.

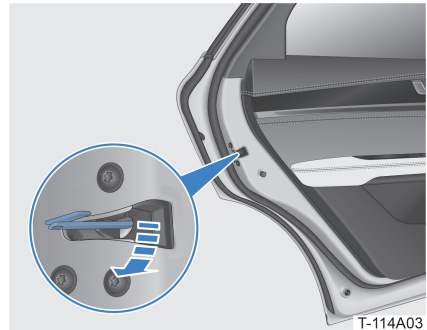

Locking:

1. Insert the mechanical key into the position shown, turn the key clockwise until it is vertical (the white slider reaches the Lock position) and take it out.
2. Close the door to lock.

REMINDER

- After the door is locked, pull the exterior door handle to confirm it has been locked successfully.

Unlocking the Boot in an Emergency

Whenever the doors and the boot fail to open from the inside in case of an emergency, the boot can be unlocked as follows:

1. Fold the backrest of the second or third row seat (if any) to access the boot.
2. Open the boot toolkit cover and take it out.

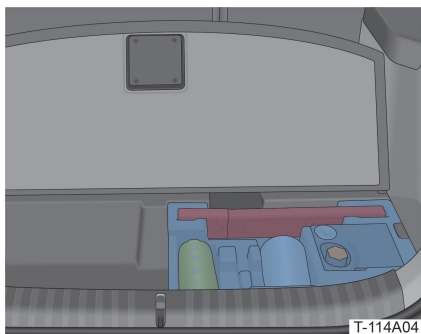

3. Pull the emergency handle and push the boot lid outwards.

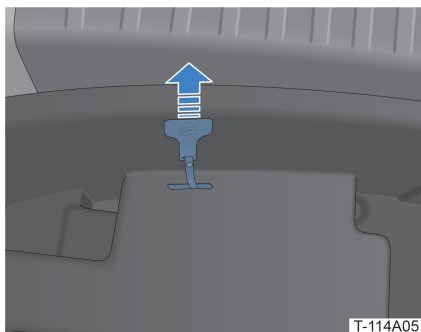

Unlocking the Charging Port in an Emergency

If the charging port lock fails and the charging connector cannot be pulled out, follow the steps below:

1. Open the boot.

2. Forcefully pull the right armrest cover out.

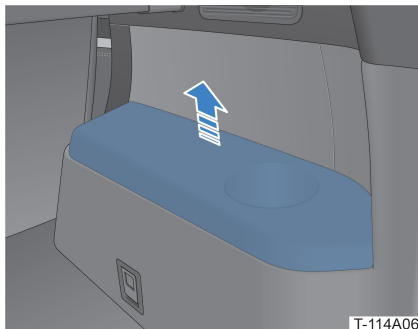

3. Pull the emergency unlocking rope to unlock.

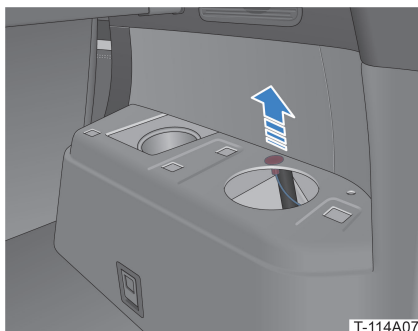

Power Boot Failure

If there has been a malfunction or failure in the power boot lid, fully closing the boot lid manually can restore its functionality. If the problem persists, contact a BYD authorised dealer or service provider.

Awakening Dormant 12V Battery (Starter Fe Battery)

When the vehicle is parked for an extended period of time, the 12V battery (starter Fe battery) may enter dormant mode. In this mode, the remote control key cannot be

used to locate or lock/unlock the vehicle.

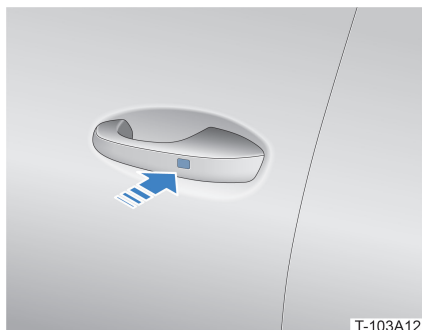

When the 12V battery (starter Fe battery) is in dormant mode, bring the remote control key into the activation area of the front left door, double press the microswitch on the handle to awaken the 12V battery (starter Fe battery), unlock the vehicle and use it normally.

! REMINDER

- If the operation above cannot awaken the vehicle, it indicates that the 12V battery (starter Fe battery) SOC may have been exhausted. Contact a BYD authorised dealer or service provider.

Turning Hazard Warning Lights

The hazard warning lights should be on to alert other road users and reduce the risk of traffic accidents when:

- The vehicle is faulty;
- The vehicle is at the rear end of a traffic jam;
- The vehicle is towing a trailer or being towed;
- Visibility is low in rainy and foggy weather.



The hazard warning lights can be turned on/off by pressing the hazard warning light switch.

When the hazard warning lights are on, the turning lights and turn signal indicators on the instrument cluster will flash.

! REMINDER

- If the hazard warning lights fail to work, other measures must be taken to alert others. The measures taken must comply with local traffic regulations.

Tools Included in the Vehicle

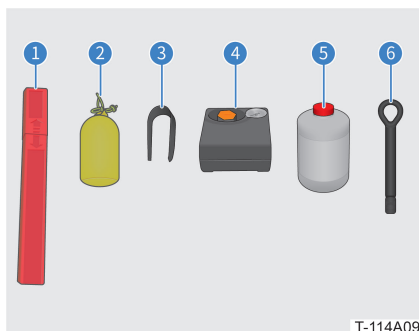

- 1 Warning triangle;
- 2 Reflective vest;

- 3 Removal clamp for wheel nut trim cover;
- 4 Inflator pump;
- 5 Tyre sealant;
- 6 Towing hook.

! REMINDER

- To best handle various kinds of emergency, be familiar with how the tools included in the vehicle are used, and where they are located.
- After use, the tools should be cleaned, put back in place, and firmly secured.

Wearing Reflective Vest



If it is ever necessary to exit the vehicle to check or deal with faults, remove the reflective vest from the toolkit and wear it before doing so. This will alert others.

! REMINDER

- A damaged or dirty vest should be replaced as soon as possible.

Using Warning Triangle

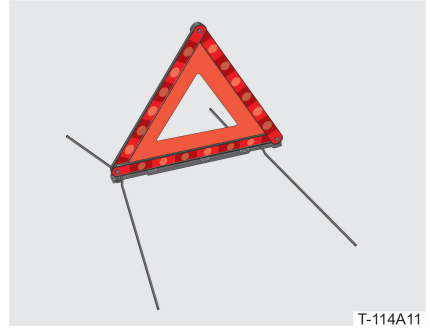

The warning triangle is stored in the toolkit. Remove it and unfold it before use.

! REMINDER

- The warning triangle must be used in compliance with local traffic regulations.

Inflating Tyres

When the tyre pressure gets low, the inflator pump can be used to quickly inflate the tyre.

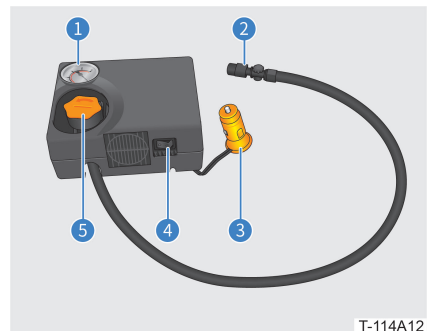

- 1 Pressure gauge;
- 2 Connector;
- 3 Power plug;

- 4 Power button;
- 5 Sealant inlet cover.

⚠ WARNING!

- Park the vehicle in a flat and safe place when inflating a tyre.
- Do not disassemble or modify the inflator pump.

⚠ CAUTION!

- The inflator pump only works with a 12V DC power supply. Do not use other power supplies.
- The inflator pump should not work continuously for over 10 minutes.
- Be sure to keep all water and dust away when using the inflator pump.

Inflation method

1. Park the vehicle in a flat and safe place, and remove the tyre valve cap.

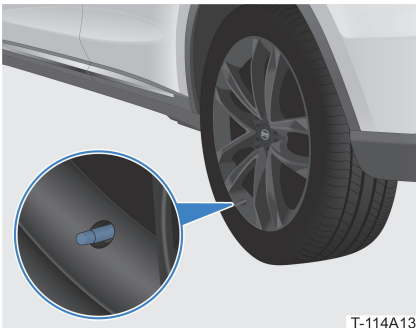

2. Screw the inflator pump connector onto the tyre valve. A slight air leakage sound will be heard from the valve, indicating that the air is circulated. Continue screwing until there is no air leakage sound.

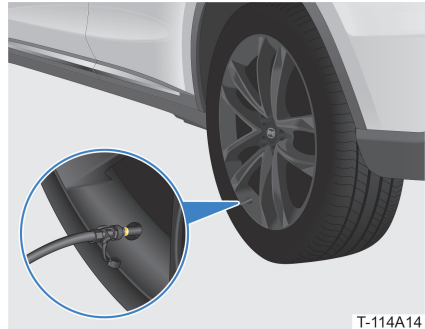

3. Plug the power plug into the on-board power supply port.
 - There is a power supply port in the boot and another in the centre console cubby.

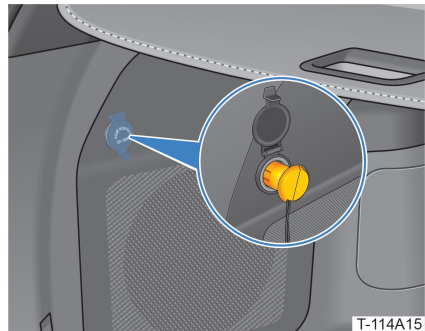

4. Start the vehicle.
5. Power the inflator pump on and start inflating.
6. Observe the pressure changes shown on the pressure gauge. Power the inflator pump off when the required air pressure is reached (refer to the **Vehicle Information - Specifications - Wheels and Tyres** section).
7. Unscrew the inflator pump connector and screw the tyre valve cap back on.
8. Unplug the inflator pump power plug and return the inflator pump to the toolkit.

Tyre Bursting/Leakage



If a tyre bursts or leaks while driving, hold the steering wheel tightly with both hands and try to keep it from steering on its own. Press the brake pedal lightly to slow down, so that the vehicle can continue moving straight. Drive slowly to a safe area and stop. Replace the tyre or contact any rescue service as needed.

WARNING!

- When repairing or replacing tyres on a public road, turn on the hazard warning light, wear the reflective vest, and position the warning triangle in a suitable place behind the vehicle as specified by local laws and regulations.

CAUTION!

- Do not continue driving on flat tyres, as this may seriously damage them.

Repairing Tyres

Repair tyres with the tyre sealant when:

- A nail stuck into the tread causes the flat tyre.
- The tread puncture is smaller than 6mm.

WARNING!

- The tyre sealant is highly flammable and harmful to health. Open flames are to be avoided, and smoking is prohibited when using the sealant. Prevent the tyre sealant from coming into contact with skin, eyes and clothing. Keep it out of the reach of children.
- If the tyre sealant comes into contact with skin or eyes, immediately wash the affected part with abundant water and seek medical advice at once.
- If any allergic reaction is observed after coming into contact with the tyre sealant, seek medical advice immediately.

Tyre Repair

1. Park the vehicle in a flat and safe place, rotate the area of the tyre leak as close to the ground as possible, and remove the tyre valve cap.
2. Remove the speed limit label from the side of the inflator pump and place it on the steering wheel where it can be easily seen.
3. Remove the sealant inlet cover and inject the tyre sealant into the inlet.

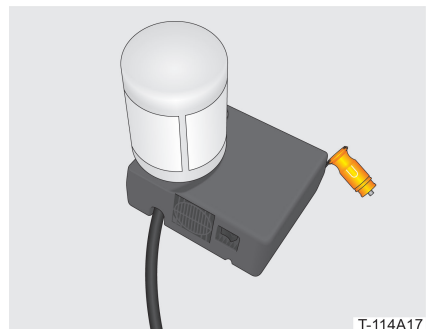

REMINDER

- The tyre sealant should be shaken thoroughly before use.
4. Screw the inflator pump connector into the tyre valve.
 5. Plug the power plug into the on-board power supply port.
 6. Start the vehicle.
 7. Power on the inflator pump and start the tyre repair.
 8. Read the tyre pressure gauge on the inflator pump.

REMINDER

- If the tyre pressure is between 180-320kPa, remove the inflator pump power plug at once. Within 1 minute, drive the vehicle for no more than 10 km at a speed below 80 km/h to allow the sealant to be distributed evenly inside the tyre.
 - If the tyre pressure does not reach 180 kPa within 10 minutes, turn off the inflator pump and contact a BYD authorised dealer or service provider.
9. After tyre repair, drive the vehicle for a short period of time and then stop to check the tyre pressure again.
 - If the tyre pressure is greater than 220 kPa, drive at a speed below 80 km/h to the nearest service provider.
 - If the tyre pressure is between 130-220kPa, inject the tyre sealant into the tyre and read the tyre pressure gauge on the inflator pump again.
 - If the tyre pressure does not reach 130 kPa, contact a BYD authorised dealer or service provider.

CAUTION!

- Repairing a damaged tyre with the tyre sealant kit is a temporary solution for emergencies only. Contact a BYD authorised dealer or service provider to replace the tyre as soon as possible. Be sure to inform maintenance technicians that the tyre has sealant inside.
- Avoid sudden acceleration or turning at high speeds.
- Do not exceed 80 km/h. Stop driving if any strong vibrations, unstable driving performance or noise appears when the vehicle is running.
- Replace any tyre sealant that is about to expire (refer to the label on the canister for the expiration date).
- After repairing a tyre with the tyre sealant kit, it is recommended that a new one is purchased from a BYD authorised dealer or service provider.

Jump Start

When the vehicle won't start due to low 12V battery (starter Fe battery), try to start it as below:

1. Open the bonnet. (Refer to **Maintenance - Refilling Oil - Opening and Closing the Bonnet**)
2. Remove the bonnet left trimming.
3. Connect one end of the red anode (+) cable to rescued vehicle 12V battery (starter Fe battery) anode (+) terminal.

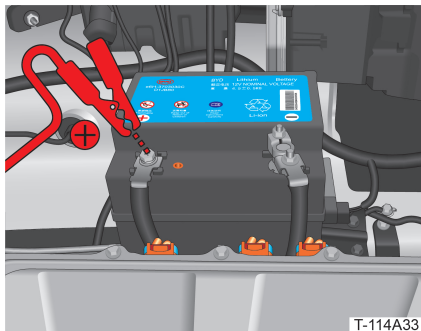

4. Connect the other end of the red anode (+) cable to rescue vehicle electric battery anode (+) terminal.

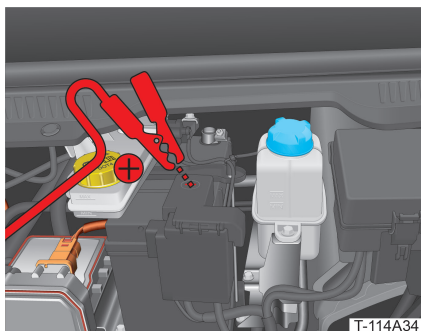

5. Connect one end of the black cathode (-) cable to rescue vehicle electric battery cathode (-) terminal.

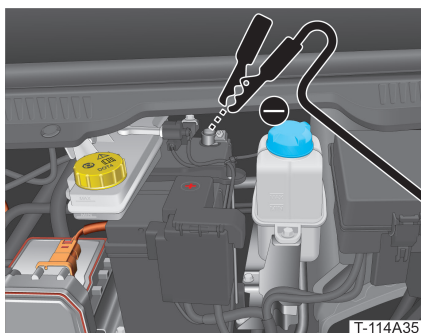

6. Connect the other end of the black cathode (-) cable to rescued vehicle corresponding GND point (clean and unpainted solid metal part).
7. Start the rescue vehicle first, and after a

while, try to start the rescued vehicle.

8. After the rescued vehicle has started, cut the rescue vehicle power supply, disconnect the jumper cables in reverse order to that of their connection, and put them away.
9. Install the bonnet left trimming and close the bonnet.

⚠ WARNING!

- There is a risk of electrical short circuit if jumper cables are connected or disconnected in the wrong order, resulting in damage to the vehicle or personal injury.
- In order to prevent short circuit when jump starting a vehicle, jumper cable clips must not contact each other or any conductive material other than their corresponding battery terminals.

⚠ CAUTION!

- If the rescued vehicle will not start after repeated attempts, please contact a BYD authorised dealer or service provider.
- The rated voltage of the rescue vehicle battery should be 12V during jump start.

Emergency Starting

If the remote control key loses power, the vehicle can still be started as follows:

1. Place the remote control key near the  icon on the auxiliary instrument cluster (in the front cup holder).



T-114A18

2. Press the brake pedal and the "START/STOP" button to start the vehicle.



T-108A01

REMINDER

- When the remote control key loses power, replace the battery as soon as possible (refer to the **Unlocking - Understanding of Keys - Remote Control Key** section).

Towing

If the vehicle needs to be towed, contact a BYD authorised dealer or service provider or a specialised towing company.

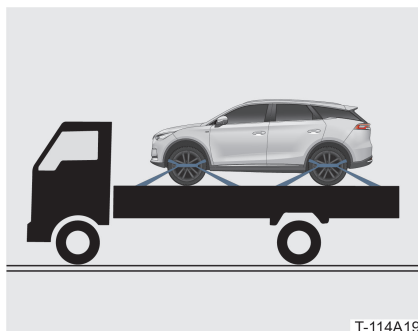

T-114A19

A flatbed truck must be used.

WARNING!

- The front and rear wheels must be off the ground when the vehicle is being towed.

Installing the Towing Hook

1. Remove the towing hook from the toolkit.
2. Pull out its cover.



T-114A20

3. Insert the towing hook into the towing hole, rotate it clockwise and tighten it.

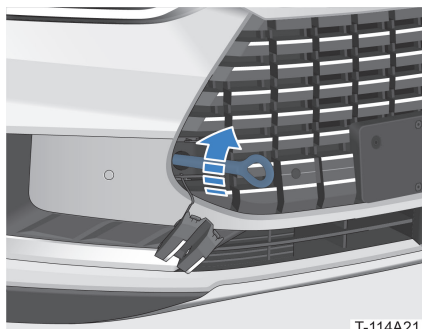

T-114A21

Installing the Trailer Hitch*

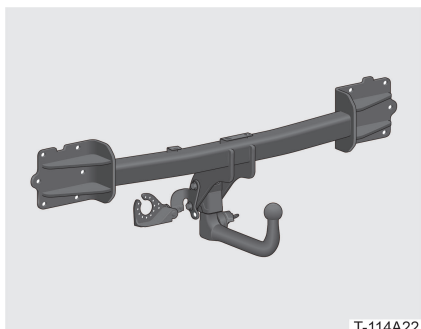

T-114A22

Trailer Hitch



T-114A23

A trailer hitch can be installed at the rear of the vehicle for towing a wagon, caravan, boat, etc.

Loading capacity:

Loading capacity

Maximum load



75 kg x 5 occupants (the front two rows)



60kg (seven-seat model, folding third row seats)

Towing limit:

Loading capacity

Maximum load



Maximum vertical load of trailer hitch: 80 kg



1500 kg (centre axle trailer); 750kg (unbraked trailer)

WARNING!

- Make sure that accessories such as the trailer hitch and safety chain are properly connected and securely installed.
- Make sure that all loaded cargos are firmly secured and evenly distributed. Failure to do so may lead to traffic accidents, vehicle damage and personal injury.
- When towing a trailer or loading cargo, please reduce speed and avoid sharp turning or sudden braking, as this may lead to traffic accidents, vehicle damage and personal injury.

CAUTION!

- Do not tow a trailer with its cargo combined weight above the trailer hitch towing capacity.
- Vehicle loading capacity should be met when a trailer hitch is used to tow a trailer or load cargo.
- A trailer towed or cargo loaded may obstruct your field of vision. Adjust the rear view and side mirrors for an improved view.
- Maintain a longer distance from vehicles ahead when towing a trailer or loading cargo.
- The vehicle becomes longer when towing a trailer or loading cargo. Therefore wider turns must be taken to prevent the towed cargo from hitting kerbs, road signs, trees or other objects.
- Do not park the vehicle on a slope when towing a trailer or loading cargo.

REMINDER

- Whenever the installation of a trailer hitch is necessary, visit a BYD authorised dealer or service provider.
- Follow local laws and regulations for installation of the trailer hitch.
- Park the vehicle in a flat and safe place when engaging or disengaging the towed trailer or loaded cargo.
- Towing a trailer or loading cargo will reduce the driving range.

Vehicle support

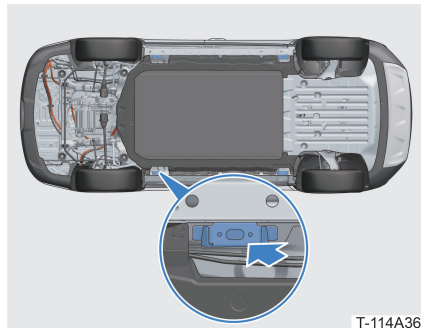

To lift or jack up the vehicle, the lifting arm or jack can only be placed at the lifting point shown in the figure above.

To ensure safety, pay attention to the following items before lifting or jacking the vehicle:

- Park the vehicle on the solid and flat ground.
- Power the vehicle off, and all passengers in the vehicle need to get off.
- When jacking up the vehicle, place a stopper block in front of the front wheel or behind the rear wheel to prevent vehicle slipping.

WARNING!

- Do not place the lifting arm or jack at the high voltage battery position.
- When lifting or jacking the vehicle, ensure that the lifting is firm, otherwise it may cause vehicle damage and personal injury.
- When jacking the vehicle with a jack, do not keep any part of human body below the vehicle.

Rescue

Vehicle Fire

If the vehicle catches fire, follow the steps below:

- Power the vehicle off.
- Locate a dry powder fire extinguisher nearby.
- If the fire is small and is spreading slowly, put out the fire with a dry powder fire extinguisher and call the police and rescue services as soon as possible.
- If the fire is large and spreading fast, keep a safe distance from the vehicle and call the police and rescue services as soon as possible.

WARNING!

- After the fire is put out, contact a BYD authorised dealer or service provider for further handling. Do not touch the vehicle after a fire to prevent accidents such as electric shock and burns.
- Put out fires with specified types of fire extinguishers. Attempting to extinguish a fire with water or other fire extinguishers may cause electric shock.

To effectively prevent vehicle fires, heed to the following precautions:

- Do not place any flammable or explosive materials in the vehicle.
- Do not modify the vehicle's wiring or install any additional electrical appliances.
- Visit a BYD authorised dealer or service provider regularly for inspection and maintenance.
- Equipping the vehicle with fire extinguishers and understanding how they are used is recommended.
- When parking the vehicle (especially in summer), make sure that there are no flammable materials (e.g., hay, dry branches and leaves or straw, etc.) under the vehicle, as they are fire hazards.

Vehicle Flooding

If you suspect water has entered the vehicle after having driven through flooded areas, follow the steps below:

- Drive away from the flooded area and park safely. Check if there is water inside the vehicle, and if there is, remove it as soon as possible.
- If the vehicle is unable to leave the area, power it off and disconnect the cathode of the 12V battery (starter Fe battery) if possible.
- Contact a BYD authorised dealer or service provider for emergency assistance immediately.
- If the vehicle is seriously flooded, all vehicle occupants should evacuate to a safe area at once.

 **WARNING!**

- Never power the vehicle on if it accidentally falls into water or is flooded due to weather or other reasons. Doing so may result in an accident or serious damage to the vehicle.

Vehicle Collision

In the event of a vehicle collision, follow the steps below:

- If conditions permit, visually check if the high voltage battery tray has cracked edges and if any fluid is visibly leaking out.
- Power the vehicle off, and disconnect the cathode of the 12V battery (starter Fe battery) if possible.
- Contact a BYD authorised dealer or service provider for emergency assistance immediately.

Battery Leakage

In case of battery leakage, keep away from the vehicle or the leaking battery and contact a BYD authorised dealer or service provider for emergency assistance.

 **WARNING!**

- Do not touch any leaks. Keep away from the vehicle or the leaking battery.

 **SUSTAINABILITY**

- Do not discard leaked substances into water, soil or other environments.

15 DATA COLLECTION AND PROCESSING

Vehicle Data Processing	200
Permanent Vehicle Transfer to Third Parties and Off-Line Mode.....	201
Disclosure of Personal Data to Authorities.....	202
Your Data Protection Rights	202

Data Collection and Processing

This section provides you with some important information on how personal data is collected and processed when you use a BYD vehicle. For a more detailed overview on data processing, data protection and data subject rights, please read the current version of the privacy policy for the vehicle available at the infotainment system (vehicle settings >DiLink >version management >privacy policy).

Vehicle Data Processing

When using the vehicle, information is collected at the vehicle. This includes data such as data collected or transmitted by vehicle sensors or control units which is necessary for the safe functioning of your vehicle. In some cases, the data is used to support driving (driver assistance systems) or to enable a specific comfort or infotainment function. Personal data that is collected and processed mainly include in-vehicle data, remote-services-related data, and other data, as further specified below.

In-Vehicle Data

Operation data

When operating the vehicle, various data on the status of the vehicle (e.g. speed, battery level, braking system) or the environment (e.g. distance sensors, rain sensor, temperature sensors) are collected and processed. This data is not usually stored, but there are control units, sensors or other components installed in the vehicle that record such data, for example to record maintenance requirements, error messages or other information. The in-vehicle data will only be stored in the equipment in the vehicle but can be read out via the legally required OBD ("On Board Diagnostics")

interface, for example by BYD authorised dealer or service provider or other third parties.

In case this access takes place during vehicle maintenance, the information can also be transmitted to BYD Europe engineers for quality assurance, product defect reports or customer claim verification.

Remote-services-related data

Remote monitoring services

Your vehicle has remote monitoring services. These include remote monitoring services such as remote diagnosis and Over-the-air (OTA) updates and upgrades for security and safety purposes (subject to your approval). These monitoring services serve the following purposes: provision of our services to you (remote support/diagnostics), product development and security/public safety.

Depending on your country and set-up, various vehicle information can be transmitted to BYD Europe for the above purposes, including vehicle location information, vehicle status, such as energy consumption, vehicle speed, gear position, power mode, ESP status, steering system status, battery status, powertrain status and overall vehicle performance status.

Other

Infotainment system

Depending on the configuration of your vehicle, you can add data to the Infotainment system of the vehicle yourself. Depending on the configuration, this includes, for example, media data for playing films on the Infotainment system, address data when using the navigation system or data for using online services. Depending on the configuration of your vehicle, you may also be able to make certain individual settings in and on the vehicle. If this data is stored in the vehicle,

you can delete it at any time. If this data is transferred to third parties (because you use third party content, in particular as part of online services) BYD Europe has no control over this.

Integration of mobile devices

Depending on vehicle configurations, mobile devices can be connected and controlled through the vehicle's infotainment system. It may be necessary that the device's screen or audio is displayed/ played through the infotainment system or transmitted to it. Additional data like positioning or vehicle information can be transmitted through applications for use in certain navigation systems, communication, or other third-party services. The specific type of data processing depends on the respective function and is controlled by the user or third parties such as the provider of the devices or corresponding services.

Internet access and connected services

Depending on vehicle configurations, the Internet can be accessed for certain functions or BYD Europe services through the vehicle's infotainment system network devices. BYD Europe is not liable for any such services provided by any other party. In such cases, please obtain information about the use of data from the provider of the respective online service.

Cameras Image recording/surrounding area monitoring

Your vehicle is equipped with a number of cameras/sensors. The reason for this is that some vehicle functionalities require the vehicle's path to be detected and assessed which is done by cameras that detect objects in the vehicle's surroundings (e.g. obstacles). The images are transmitted to the respective control module for further analytics required to operate the systems. Some images are just processed on a volatile basis (RAM), others may be stored, depending on vehicle equipment.

The vehicle may be equipped with an

Outward Facing Camera (OFC) that can be used to take a footage of the surrounding (dashcam). The vehicle may also be equipped with an Inward Facing Camera (IFC) which can be used to take a footage inside the vehicle. Both video footages are stored in-vehicle. You are responsible to check the laws of your residence if you turn the camera on. Please be aware of the legal requirements before turning either the OFC or the IFC on (in some countries for IFC you need to obtain consent and other heavily restrict the use of OFC for dashcam purposes, for example).

For more details on camera options, go to **Section Trip Record and Section Panoramic View** of this owner's manual.



Permanent Vehicle Transfer to Third Parties and Off-Line Mode



In case of a permanent transfer of the vehicle, i.e. if you have purchased your vehicle used, or if the vehicle was transferred to you by another person for permanent use, you should note that any personalisation/user settings via the infotainment system (e.g. address list, navigation system etc.) may be accessed by the new user. You can reset these settings to the factory settings by tapping on  **>DiLink>Version management>Reset vehicle system to default>Reset** the centre console touchscreen.



You can also restrict your vehicle's communication with the BYD data server and the processing of vehicle-related and

personal data by setting the vehicle to the offline mode

Tap on  to turn Wi-Fi off. **Wi-Fi** can also be turned off by tapping on  /  > **DiLink** > **Connection** on the centre console touchscreen.

Tap on  to turn Cellular Data off. **Network** can be turned off by tapping on  /  > **DiLink** > **Connection** on the centre console touchscreen.



Disclosure of Personal Data to Authorities

BYD discloses your personal data only insofar to third parties as this is legally permissible or you have consented to it. However, subject to the applicable laws, government agencies may be authorised to read out data from vehicles (e.g. data can be read from the airbag control unit to clarify an accident). If required by law BYD may also be obliged to disclose data upon request to governmental authorities in your country, e.g. in the event of the investigation of a criminal offence.

Your Data Protection Rights

BYD has staunch respect for its customer's privacy, and strictly complies with all data protection laws, in particular the General Data Protection Regulation (GDPR) and applicable local laws. According to these laws, owners have specific rights when

their personal data is processed:

Data subjects have the right of information and access, to rectification, erasure of personal data ('right to be forgotten') and the right to object to the processing of personal data or to restrict it (or to withdraw consent given earlier, as well as the right to data portability).

These rights may be limited in some cases - for example, if we can show that we have a legal obligation to process your data, or if providing the information to you would disclose personal data about another person, or if we are legally prevented from disclosing that information. In some cases, this may mean that we can retain the data even if you withdraw your consent.

For more information on data processing, data protection and any rights you may have, please visit the latest version of the Privacy Policy available at the infotainment system (vehicle settings >DiLink >version management >privacy policy).

16

VEHICLE INFORMATION

Vehicle Information	204
Specifications.....	208

Vehicle Information

Vehicle Identification Number (VIN)

VIN position

VIN is the unique identity code of a vehicle.

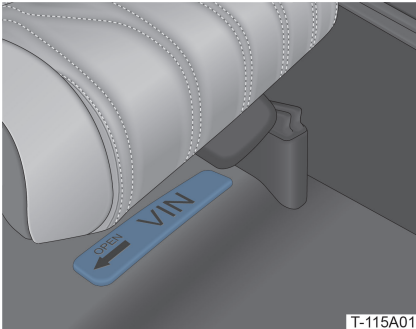

The VIN is printed on a label under the front passenger seat.

VIN composition

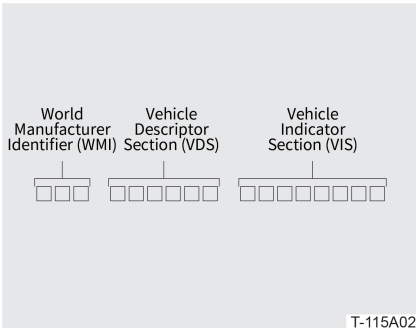

The VIN comprises 17 characters and includes information about the vehicle such as the country of origin, manufacturer, model year, vehicle characteristic code, etc.

Using a Diagnostics Device to Read VIN

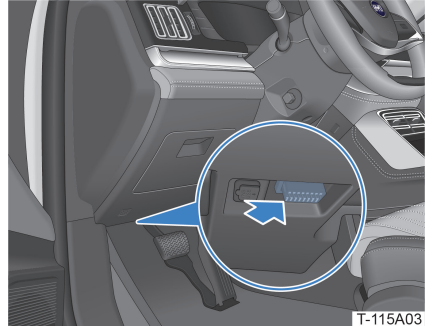

The OBD port is located at the left lower part of the dashboard. A special diagnostics device, when connected to the OBD port, can read the VIN, vehicle status and other data.

Vehicle Nameplate and Label

Manufacturer Nameplate

The manufacturer nameplate is located at the lower part of the right B pillar.



Five-seat model



T-115A19

Seven-seat model



T-115A06

The model and number labels for the front drive motor are pasted on the inner side of the bonnet.



T-115A04

The manufacturer label is located at the lower part of the left B pillar.

Motor Model and Number

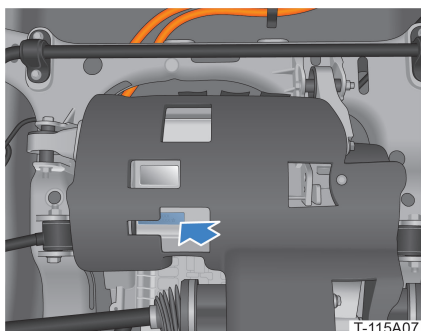

T-115A07

The model and number of the rear drive motor are inscribed on the rear drive motor housing.

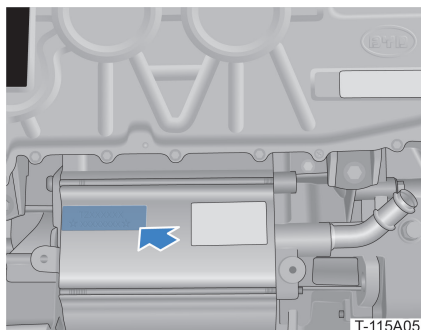

T-115A05

The model and number of the front drive motor are inscribed on the front drive motor housing.

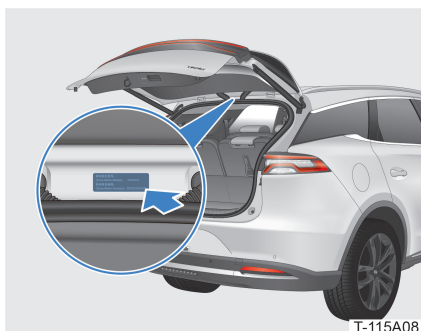

T-115A08

The model and number labels for the rear drive motor are pasted on the boot lid.

Vehicle Labels

Vehicle labels include airbag warning label, cooling fan warning label, high-voltage component warning label, etc. Please read and follow the instructions on all labels.



Side Airbag Warning Label

The side airbag warning label is pasted at the lower part of both B pillars.



Front Airbag Warning Label

The front airbag warning label is hot-stamped on the right sun visor.



Tyre Pressure Label

The tyre pressure label is pasted at the lower part of the left B pillar.

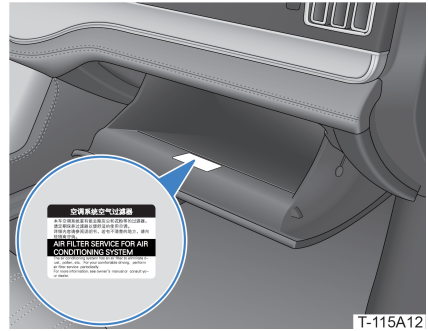

Air Filter Label

The air filter label is pasted inside the glove box.



Battery Position Indication Label

The indication label for battery position is pasted on the inner side of the bonnet.



T-115A14

Refrigerant Refill and Cooling Fan Warning Labels

The warning labels for refrigerant refill and cooling fan are pasted on the inner side of the bonnet.

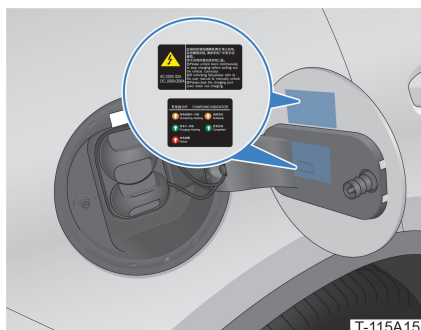

T-115A15

Charging Indicator and Reminder Labels

The labels for charging indicator and reminder are pasted on the inner side of the charging port hatch.



T-115A16

Boot lid Opening Label

The boot lid opening label is pasted on the part above the exterior boot lid opening button.



T-115A17

High-voltage Components Warning Labels

The warning labels for high-voltage components such as motor controller are pasted on their enclosures.

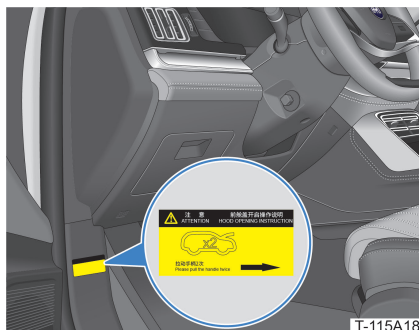

T-115A18

Bonnet Opening Label

The label for bonnet opening is pasted at the lower part of the left A pillar.

Specifications

Vehicle Specifications

Item	Parameters		
Model	TANG EV		
Overall dimensions (mm)	Length	4870	
	Width	1950	
	Height	1725	
Wheel tread (mm)	Front	1650	
	Rear	1630	
Wheelbase (mm)	2820		
Front/rear overhang (mm)	985/1065		
Curb weight (kg)	2489		
Axle load (curb weight) (kg)	Front	1183	
	Rear	1306	
Gross Combined Weight Rating (GCWR) (kg)	3060	3060	
Axle load (GCWR) (kg)	Front	1264	1291
	Rear	1769	1769
Minimum ground clearance at full load (mm)	150		
Minimum turning diameter (m)	11.8		
Top speed (km/h)	180		
Maximum gradeability (%)	50		
WLTP driving range (km)	400		
Electric range WLTP city (km)	528		
WLTP power consumption (Wh/km)	238		
Approach angle (°)	22		
Departure angle (°)	20		
Seating capacity (occupants)	5*	7*	

Motor

Item	Parameters	
Motor model	TZ200XSN (Front)	TZ200XSE (Rear)
Type of drive motor	PMSM	PMSM
Drive type	All wheel drive (AWD)	All wheel drive (AWD)
Rated power (kW)	65	65
Rated RPM (r/min)	6000	6000
Rated torque (N•m)	135	130
Peak power (kW)	180	200
Peak RPM (r/min)	15500	15500
Peak torque (N•m)	330	350

High-Voltage Battery

Item	Parameters
Model	PA4
Battery type	Lithium iron phosphate battery
Rated voltage (V)	640
Rated capacity (Ah)	135
Cooling mode	Coolant cooling

Wheels and Tyres

	Item	Parameters
	Tyres	265/40R22 255/50R20*
	Standard tyre pressure (kPa)	260 290 (rear wheels for more than 4 occupants)
Four-wheel alignment	Front wheel toe-in	0±2mm
	Front wheel camber	-0.48° ±0.75°
	King pin caster angle of front wheel	2.78° ±0.75°
	King pin inclination angle of front wheel	11.13° ±0.75°
	Rear wheel camber	-0.75° ±0.75°
	Rear wheel toe-in	3±2mm
	Wheel balance (g)	<10

Brake System

Item	Parameters	
Type of service brake system	Hydraulic dual circuit, X-pattern circuit	
Type of parking brake system	EPB	
Reasonable service limit of brake friction pair	Total thickness of front brake pad (mm)	9.85
	Allowable wear thickness of front brake pad (mm)	2.75~9.85 (thickness after wear)
	Total thickness of front brake disc (mm)	34
	Allowable wear thickness of front brake disc (mm)	32~34 (thickness after wear)
	Total thickness of rear brake pad (mm)	11.1
	Allowable wear thickness of rear brake pad (mm)	3~11.1 (thickness after wear)
	Total thickness of rear brake disc (mm)	30
	Allowable wear thickness of rear brake disc (mm)	28~30 (thickness after wear)

Fluid Types and Usage

Item	Specification	Quantity	
Brake fluid	HZY6	1154±15mL	
Refrigerant	R-1234yf	720±20g	
Coolant for battery thermal management system	-40°C freezing point	5.0±0.2L	
Motor coolant	-40°C long-acting organic acid coolant	9.3±0.2L	
Windscreen washer fluid	-30°C ethanol	2L	
Gearbox oil	BYDNT33 (Front)	Shell S3-ATF-MD3	0.85±0.1L
	BYDNRT33 (Rear)	Shell S3-ATF-MD3	0.95±0.1L

A

A/C	60
AC Charging with Charging Pile Charger	145
AC Charging with Household Charging Equipment.....	144
A/C System Maintenance	169
Activating Infotainment System	72
Adaptive Cruise Control (ACC)	98
Adjusting Front Seat Belt Height	46
Adjusting Instrument Cluster Brightness	81
Adjusting Seat	57
Airbags.....	116
Anti-Corrosion Measures	171
Anti-Theft Alarm	151
Auto Folding/Unfolding.....	153
Automatic Vehicle Hold (AVH)	90
Auto Unlocking.....	136
Awakening Dormant 12V Battery (Starter Fe Battery).	187

B

Blind Spot Detection (BSD).	105
Bluetooth Phone Call.....	75
Boot Light	31
Brake/Accelerator Pedal	91
Brake System.....	211

C

Charging Instructions	140
Charging Port Lock.....	143
Checking Brake Fluid	174
Checking Coolant.....	173
Checking/Replacing Fuses .	175
Checking Seat Belt System ...	47
Classification of Child Safety Seats (not provided with the vehicle)	41
Closing Sunroof.....	136
Closing Windows.....	136
Compatibility of Vehicle and Charging Infrastructure	147
Controlling Passenger Window	57
Controlling Rear Windows	58
Correct Sitting Posture.....	43
Correct Use of Seat Belts	44

D

Dashcam.....	124
DC Charging.....	146
Description of Power Status .	47
Disclosure of Personal Data to Authorities.....	202
Driver Seat Controls.....	48
Driver Window Control	51
Driving in Cold Weather	123
Driving in Fog	122
Driving in Hot Weather.....	123
Driving in Rain	122

E

Electronic Child Protection Lock	40
Electronic Parking Brake (EPB)	89
Emergency Starting.....	193
Exiting Courtesy	137
Exterior	10
Exterior Cleaning.....	159
Exterior Handle.....	36
Exterior Lights	91
Exterior Welcoming.....	36

F

File Manager	75
Fluid Types and Usage	211
Folding Seats.....	59
Folding Third Row Seats*	32
Front Wipers Control.....	95
Fuse Distribution.....	176

H

Headlights after Exit.....	153
Headlights before Entry.....	153
High Beam Assist (HMA).....	94
High-Voltage Battery.....	209
High-Voltage Battery Maintenance.....	164

I

Inflating Tyres.....	189
----------------------	-----

Installing a Child Seat	41
Instrument Cluster Control... ..	80
Instrument Cluster Overview.....	78
Instrument Cluster Warning Lights/Indicators	82
Integrated Power Brake (IPB)	111
Intelligent Cruise Control (ICC)*	97
Interior	12
Interior Cleaning	160
Interior Greeting.....	37
Interior Maintenance	162
Interior Roof Handle	66
Interior Storage	26
In-Vehicle Camera	125

J

Jump Start.....	192
-----------------	-----

K

0-100 km/h: Full Throttle Experience	126
--	-----

L

Lane Departure Warning System (LDWS)	104
Lane Keeping System (LKS)*	102
Loading.....	33
Locking Doors from Inside....	57
Locking with the Interior Boot Lid Switch	151

Locking with the Microswitch	150	Panoramic Sunroof/Sunshade	64
Locking with the NFC Key Card*	151	Panoramic View.....	131
Long-Term Parking.....	172	Park Assist	130
Luggage Compartment Cover*	32	Permanent Vehicle Transfer to Third Parties and Off-Line Mode	201
Luggage Lashing Eyes	31	Power Boot Failure.....	187
M		Powering Off.....	136
Main Interface.....	73	Predictive Emergency Braking System (PEBS)	108
Maintaining the 12V Battery (Starter Fe Battery).....	162	Pre-Driving Inspection	16
Maintenance Schedule	156	Protective Effect of Seat Belts	43
Manual Folding/Unfolding .	152		
Media Centre	75	R	
Microswitch	23	Reaching Third Row Seats	58
Motor	209	Rear view mirror Controls.....	53
N		Rear Wiper Control.....	96
NFC Key Card	23	Refilling Windscreen Washing Liquid.....	173
NFC Key Card*	21	Regenerative Braking.....	126
O		Remote Control Key 18, 22, 150	
On-Board Power Supply	67	Repairing Tyres.....	191
Opening and Closing the Bonnet.....	172	Replacing Seat Belt System Components.....	47
Opening/ Closing Boot Lid ...	28	Replacing Wiper Blades	170
Open Window/Sunroof Alarm	137	Riding Instructions for Children	40
P		Roof Rack.....	33
Paint Maintenance	161	S	
		Scheduled charging	145
		SD Card Slot.....	68

Seat Belt Pre-Tensioner	46
Seat Belt Reminder	47
Second Row Lighting	58
Shifting Gears	88
Side Mirror Auto-Tilt.....	130
Side Mirror Controls.....	51
Smart Charging	146
Smartphone Wireless Charging	66
Speed Sensing Auto Lock ...	126
Starting the Vehicle.....	86
Steering Wheel Controls	53
Sunroof Maintenance.....	169
Sun Visors	65
Switching Driving/Terrain Modes	86
Switching to Steering Assist .	87

T

Third Row Lighting.....	59
Tools Included with the Vehicle	188
Towing	194
Traffic Sign Recognition (TSR)*	107
Turning Hazard Warning Light On	188
Tyre Burst/Leakage	191
Tyre Maintenance.....	166
Tyre Pressure Monitoring System (TPMS)	121

U

Unlocking	22
-----------------	----

Unlocking/Locking.....	186
Unlocking with the Interior Door Handle	137
Unlocking with the "Unlock" Button.....	136
USB Ports.....	68
Using Warning Triangle.....	189

V

Vehicle Collision	197
Vehicle Data Processing.....	200
Vehicle Fire	196
Vehicle Flooding.....	197
Vehicle Identification Number (VIN)	204
Vehicle Nameplate and Label	204
Vehicle Settings.....	75
Vehicle Specifications.....	208

W

Waxing the Vehicle	161
Wearing Reflective Vest.....	189
Wearing Seat Belts When Pregnant	45
Wheels and Tyres	210
With Remote Control Key	21

Y

Your Data Protection Rights	202
-----------------------------	-----

BUILD YOUR DREAMS